

C1000A Electronic Governor Instruction

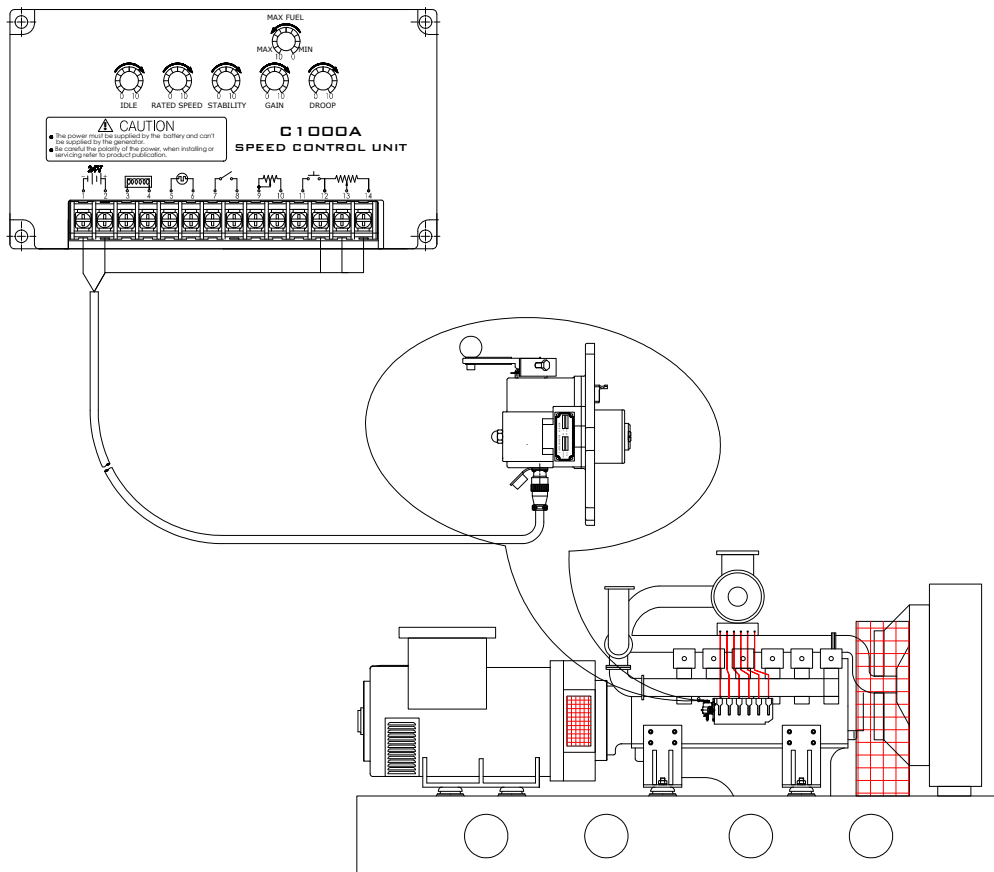

CATALOGUE

1	The Principle Of The Electronic Controller.....	1
2	The Structure Of The Electronic Controller System.....	2
2.1	Speed Controller.....	2
2.2	The Electronic Actuator.....	3
2.3	Speed Pickup.....	4
3	Installing and Debugging.....	4
3.1	Installing Of The Governor Controller.....	4
3.2	Connection Diagram Of The ESG1000 Electric Control System.....	4
3.3	Adjustment Before Starting Engine.....	5
3.4	Adjustment Of The Controller After Starting.....	6
3.5	Speed Droop Operation.....	6
4	TROUBLE SHOOTING.....	7
4.1	Insufficient Magnetic Speed Sensor Signal.....	7
4.2	Electromagnetic Interference(EMC).....	7

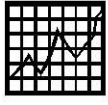

1 The Principle Of The Electronic Controller

Electronic governor, with its simple structure, high reliability, convenient operation, easy function extension and high cost performance, applies to various kinds of diesel generating sets, vehicles and marine diesel engines.

Its normal type is all-electronic single pulse speed and close loop position structure and is provided with functions of non-corresponding or corresponding control, speed and rated speed during running. maximum fuel supply control, emergency stop, etc

It is also capable to add other control functions according to the custom's particular requirements.

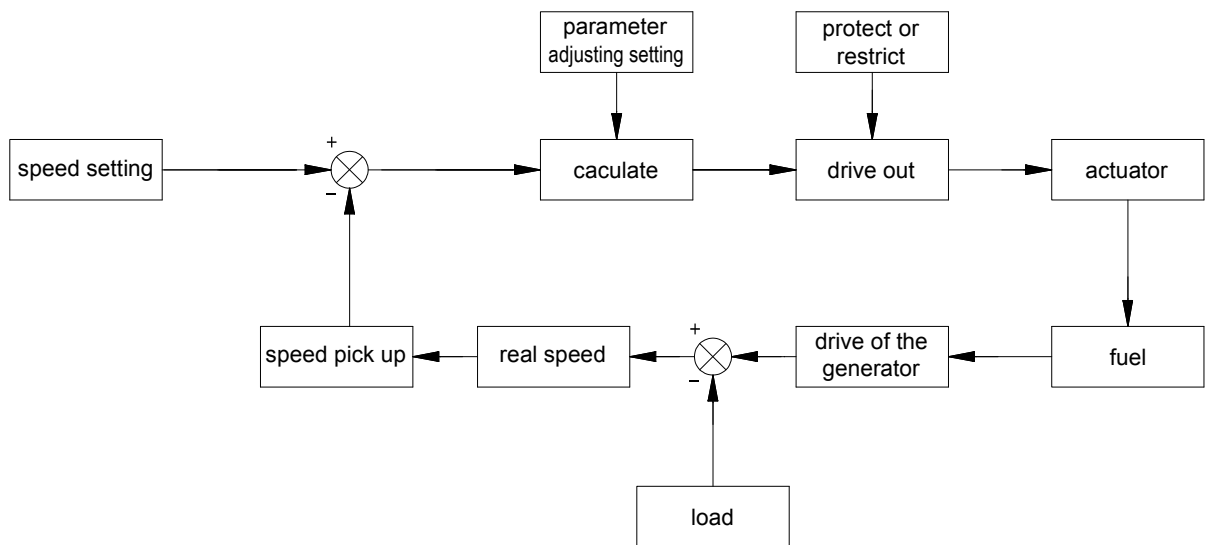
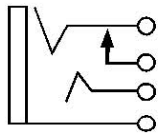

Figure1.1 Electronic controller system



2 The Structure Of The Electronic Controller System

2.1 Speed Controller

2.1.1 The basic electronic characteristics

- SUPPLY VOLTAGE : DC24V
- SUPPLY CONSUMPTION : <0.1A
- SPEED FLUCTUATION RATIO : $\leq \pm 0.25\%$
- STATIC SPEED REGULATION : 0~5%
- AMBIENT TEMP. : $-40^{\circ}\text{C} \sim +70^{\circ}\text{C}$
- RELATIVE HUMIDITY : <95%

2.1.2 The outline and installing size of the governor controller

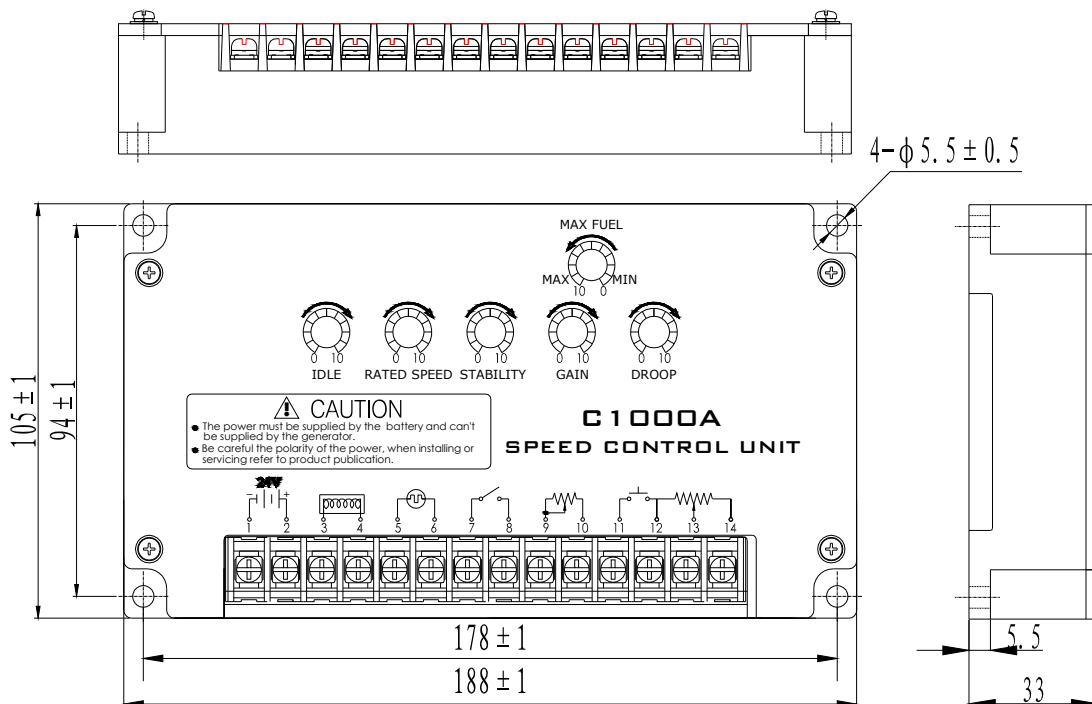

Figure 2.1: The outline and installing size of the C1000A governor controller

2.1.3 Connection diagram of the governor controller

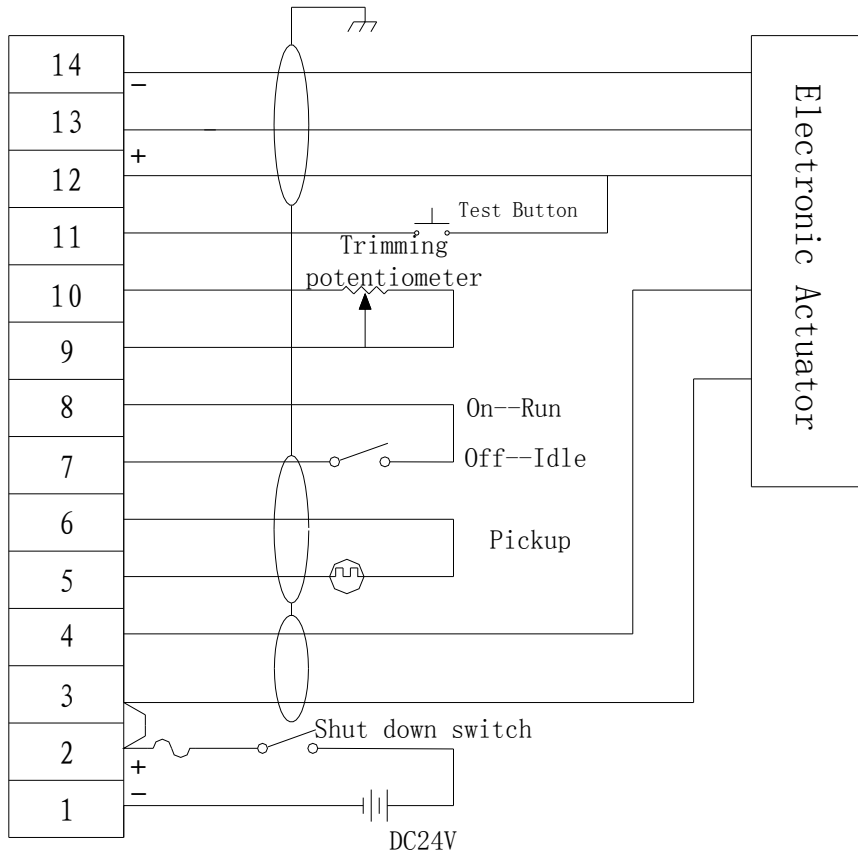

Figure 2.2 Connection diagram of controller of the C1000A

2.2 The Electronic Actuator

2.2.1 The outline and installing size of the electronic actuator

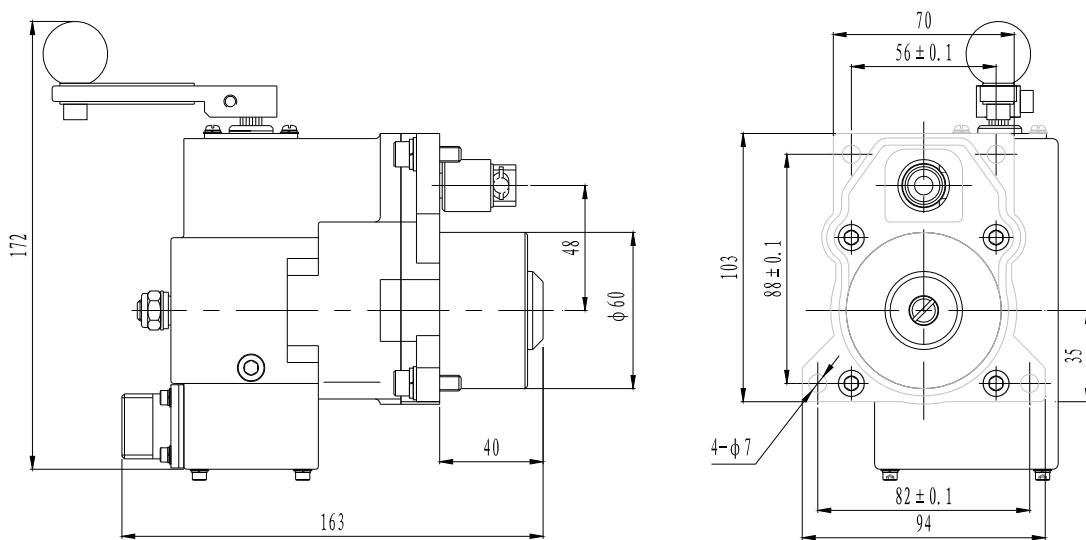

Figure 2.3 The outline and installing size of the electronic actuator

2.3 Speed Pick-up

2.3.1 The structure of the speed pick-up

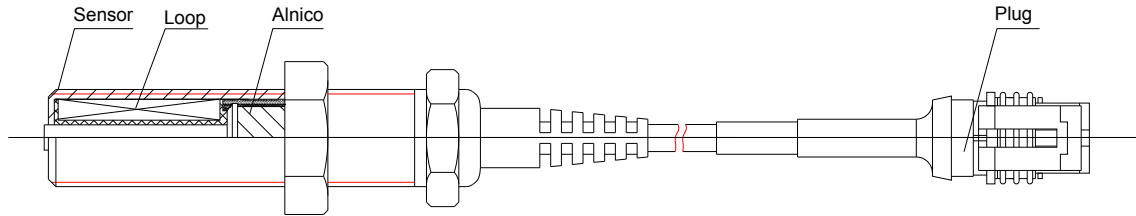
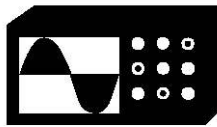

Figure 2.4: The structure of the speed pick-up



3 Installing and Debugging

3.1 Installing Of The Governor Controller

The C1000A Series speed control unit is rugged enough to be placed in a control cabinet or engine mounted enclosure with other dedicated control equipment. If water, mist, or condensation may come in contact with the controller, it should be mounted vertically. This will allow the fluid to drain away from the speed control unit.

Warning !

An overspeed shutdown device, independent of the governor system, should be provided to prevent loss of engine control which may cause personal injury or equipment damage. Do not rely exclusively on the governor system electric actuator to prevent overspeed. A secondary shut off device, such as a fuel solenoid, should be used.

3.2 Connection Diagram Of The C1000A Electric Control System

3.2.1 Basic electrical connections are illustrated in Diagram 3.1. Actuator connections to Terminals 3、4、12、13 and 14, battery connections to Terminals 1 and 2. Terminals 1、2、3、4、12、13 and 14 should be #16 AWG (1.3 mm sq.) or larger. Long cables require an increased wire size to minimize voltage drops.

3.2.2 The battery positive (+) input, Terminal 2, should be fused for 15 amps as illustrated.

3.2.3 Magnetic speed sensor connections to Terminal 5 and 6 *MUST BE TWISTED AND/OR SHIELDED* for their entire length. The speed sensor cable shield should only be connected to Terminal 6. The shield should be insulated to insure no other part of the shield comes in contact with engine ground, otherwise stray speed signals may be introduced into the speed control unit. With the engine stopped, adjust the gap between the magnetic speed sensor and the ring gear teeth. The gap should not be any smaller than 0.020in.(0.45 mm). Usually, backing out the speed sensor 3/4 turn after touching a ring gear tooth will achieve a satisfactory air gap. The magnetic speed sensor voltage should be at least 1 VAC RMS during cranking.

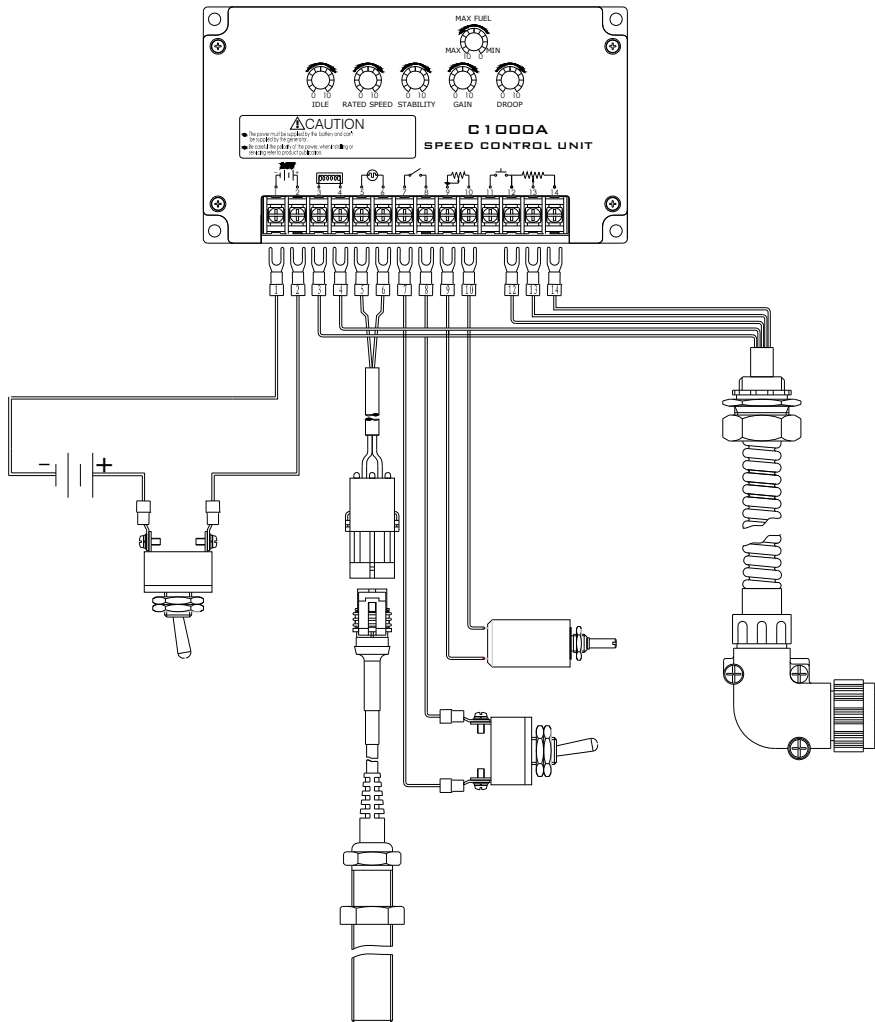

Figure 3.1 Connection diagram of the C1000A electric control system

3.3 Adjustments Before Starting Engine

Check to insure the DERIVATIVE and GAIN adjustments, and if applied, the external SPEED TRIM CONTROL are set to mid position.

The speed control unit governed speed setting is factory set at approximately engine idle speed.(1000Hz. Speed sensor signal)

The speed switch is factory set at its maximum speed setting.(10,000Hz. Speed sensor signal)

3.4 Adjustment Of The Controller After Starting

3.4.1 Crank the engine with D.C. battery power applied to the governor system. The actuator will energize fully to the maximum fuel position until the engine starts. The governor system should control the engine at low idle speed. If the engine is unstable after starting, turn the GAIN and DERIVATIVE adjustments counterclockwise until the engine is stable.

3.4.2 The governed speed set point is increased by clockwise rotation of the SPEED adjustment control. Remote speed adjustment can be obtained with an optional Speed Trim Control.

3.4.3 Once the engine is at the operating speed and at no load, the following governor performance adjustments can be made.

3.4.3.1 Rotate the GAIN adjustment clockwise until instability develops. Gradually move the adjustment counterclockwise until stability returns. Move the adjustment one division further counterclockwise to insure stable performance.

3.4.3.2 Rotate the DERIVATIVE adjustment clockwise until instability develops. Gradually move the adjustment counterclockwise until stability returns. Move the adjustment one division further counterclockwise to insure stable performance.

3.4.3.3 Gain and DERIVATIVE adjustments may require minor changes after engine load is applied. Normally, adjustments made at no load achieve satisfactory performance. A strip chart recorder can be used to further optimize the adjustments.

3.4.4 After the governor speed setting has been adjusted, place the optional external selector switch in the IDLE position. The idle speed set point is increased by clockwise rotation of the IDLE adjustment control. When the engine is at idle speed, the speed control unit applies droop to the governor system to insure stable operation.

3.5 Speed Droop Operation

3.5.1 Droop is typically used for the paralleling of engine driven generators.

3.5.2 The opposite side revolves and can enlarge the " DROOP", and adjust the scope is: 0~5%.

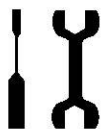

4 System Troubleshooting

4.1 Insufficient Magnetic Speed Sensor Signal

A strong magnetic speed sensor signal will eliminate the possibility of missed or extra pulses. The speed control unit will govern well with 0.5 volts RMS speed sensor signal. A speed sensor signal of 3 volts RMS or greater at governed speed is recommended. Measurement of the signal is made at Terminals 3 and 4.

The amplitude of the speed sensor signal can be raised by reducing the gap between the speed sensor tip and the engine ring gear. The gap should not be any smaller than 0.020in.(0.45mm) .When the engine is stopped, back the speed sensor out by 3/4 turn after touching the ring gear tooth to achieve a satisfactory air gap.

4.2 Electromagnetic Interference(EMC)

EMI SUSCEPTIBILITY —The governor system can be adversely affected by large interfering signals that are conducted through the cabling or through direct radiation into the control circuits.

All speed control units contain filters and shielding designed to protect the units sensitive circuits from moderate external interfering sources

Although it is difficult to predict levels of interference, applications that include magnetos, solid state ignition systems, radio transmitters, voltage regulators or battery chargers; should be considered suspect as possible interfering sources.

If it is suspected that external fields either those that are radiated or conducted, are or will affect the governor systems operation; it is recommended to use shielded cable for all external connections. Be sure that only one end of the shields including the speed sensor shield , is connected to a single point on the case of the speed control unit . Mount the speed control unit to a grounded metal back plate or place it in a sealed metal box.

Radiation is when the interfering signal is radiated directly through space to the governing system .To isolate the governor system electronics from this type of interference source, a metal shield or a solid metal container is usually effective.

Conduction is when the interfering signal is conducted through the interconnecting wiring to the governor system electronics. Shielded cables and installing filters are common remedies.