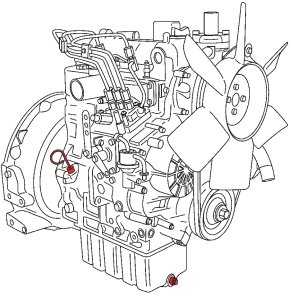
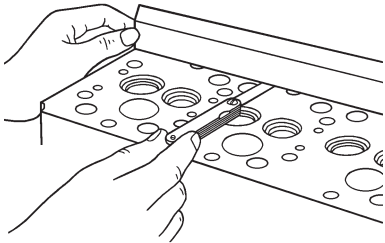
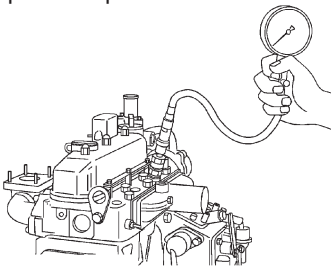
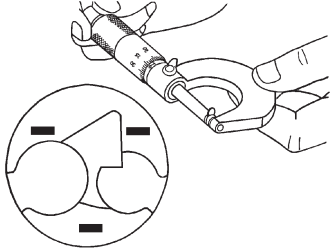
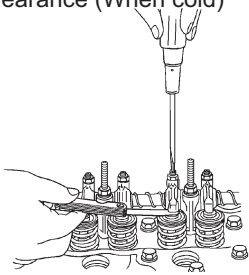
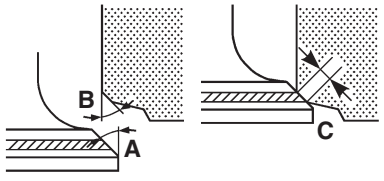
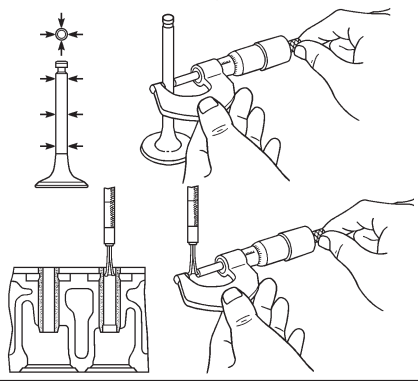
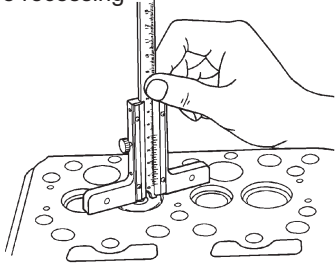
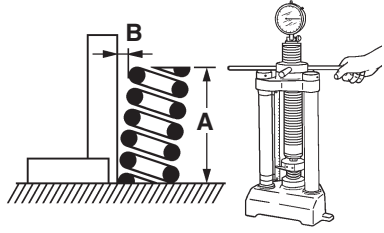
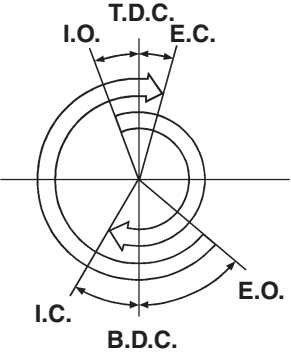
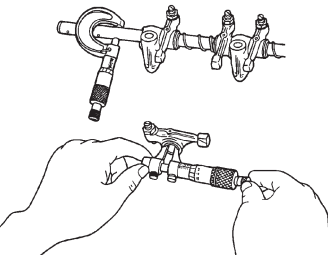
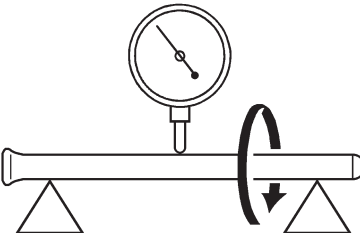
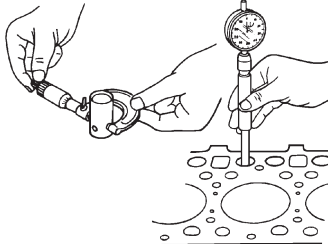

SERVICING SPECIFICATIONS

(1) ENGINE BODY

Item			Factory Specification	Allowable Limit
Lubricating oil capacity 	Oil pan depth 125 mm (4.92 in.)	D905-E2B D1005-E2B D1105-E2B D1105-T-E2B	5.1 L 1.35 U.S.gals. 1.12 Imp.gals.	—
		V1305-E2B V1505-E2B	6.0 L 1.59 U.S.gals. 1.32 Imp.gals.	—
		V1505-T-E2B	6.7 L 1.77 U.S.gals. 1.47 Imp.gals.	—
	Oil pan depth 101 mm (3.98 in.)	D905-E2B D1005-E2B D1105-E2B D1105-T-E2B	4.0 L 1.06 U.S.gals. 0.88 Imp.gals.	—
		V1305-E2B V1505-E2B	4.7 L 1.24 U.S.gals. 1.03 Imp.gals.	—
		V1505-T-E2B	—	—
Cylinder head surface 	Flatness	All models	—	0.05 mm / 500 mm 0.0020 in. / 19.69 in.
Compression pressure 		All models	2.84 to 3.23 MPa 29.0 to 33.0 kgf/cm ² 412 to 469 psi	2.25 MPa 23.0 kgf/cm ² 327 psi
Top clearance 		All models	0.55 to 0.70 mm 0.0217 to 0.0276 in.	—

Item		Factory Specification	Allowable Limit
Valve clearance (When cold) 		All models 0.145 to 0.185 mm 0.00571 to 0.00728 in.	—
Valve & valve seat 	Face angle (A) (Intake)	All models 1.047 rad. 60°	—
	Face angle (A) (Exhaust)	All models 0.785 rad. 45°	—
	Seat angle (B) (Intake)	All models 1.047 rad. 60°	—
	Seat angle (B) (Exhaust)	All models 0.785 rad. 45°	—
	Seat width (C) (Intake)	All models 2.12 mm 0.0835 in.	—
	Seat width (C) (Exhaust)	All models 2.12 mm 0.0835 in.	—
Valve stem to valve guide 	Clearance	All models 0.035 to 0.065 mm 0.00138 to 0.00256 in.	0.1 mm 0.0039 in.
	Valve stem O.D.	All models 6.960 to 6.975 mm 0.27402 to 0.27461 in.	—
	Valve guide I.D.	All models 7.010 to 7.025 mm 0.27598 to 0.27657 in.	—
Valve recessing 		All models 0.05 mm (Protrusion) to 0.25 mm (Recessing) 0.0020 in. (Protrusion) to 0.0098 in. (Recessing)	0.4 mm (Recessing) 0.0157 in. (Recessing)
Valve spring 	Free length (A)	All models 37.0 to 37.5 mm 1.457 to 1.476 in.	36.5 mm 1.437 in.
	Tilt (B)	All models —	1.0 mm 0.039 in.
	Setting load / Setting length	All models 117.4 N / 31.0 mm 11.97 kgf / 31.0 mm 26.4 lbs / 1.220 in.	100.0 N / 31.0 mm 10.2 kgf / 31.0 mm 22.5 lbs / 1.220 in.

Item			Factory Specification	Allowable Limit
<p>Valve timing</p> 	Open (Intake valve)	D905-E2B D1005-E2B D1105-E2B V1305-E2B V1505-E2B	0.24 rad. before T.D.C. 14° before T.D.C.	—
		D1105-T-E2B V1505-T-E2B	0.38 rad. before T.D.C. 22° before T.D.C.	—
	Close (Intake valve)	D905-E2B D1005-E2B D1105-E2B V1305-E2B V1505-E2B	0.52 rad. after B.D.C. 30° after B.D.C.	—
		D1105-T-E2B V1505-T-E2B	0.82 rad. after B.D.C. 47° after B.D.C.	—
	Open (Exhaust valve)	D905-E2B D1005-E2B D1105-E2B V1305-E2B V1505-E2B	0.96 rad. before B.D.C. 55° before B.D.C.	—
		D1105-T-E2B V1505-T-E2B	0.91 rad. before B.D.C. 52° before B.D.C.	—
	Close (Exhaust valve)	D905-E2B D1005-E2B D1105-E2B V1305-E2B V1505-E2B	0.24 rad. after T.D.C. 14° after T.D.C.	—
		D1105-T-E2B V1505-T-E2B	0.30 rad. after T.D.C. 17° after T.D.C.	—
<p>Rocker arm shaft to rocker arm</p> 	Clearance	All models	0.016 to 0.045 mm 0.00063 to 0.00177 in.	0.1 mm 0.0039 in.
	Rocker arm shaft O.D.	All models	11.973 to 11.984 mm 0.47138 to 0.47181 in.	—
	Rocker arm I.D.	All models	12.000 to 12.018 mm 0.47244 to 0.47315 in.	—
<p>Push rod</p> 	Alignment	All models	—	0.25 mm 0.0098 in.
<p>Tappet to tappet guide</p> 	Clearance	All models	0.020 to 0.062 mm 0.00079 to 0.00244 in.	0.07 mm 0.0028 in.
	Tappet O.D.	All models	19.959 to 19.980 mm 0.78579 to 0.78661 in.	—
	Tappet guide I.D.	All models	20.000 to 20.021 mm 0.78740 to 0.78823 in.	—

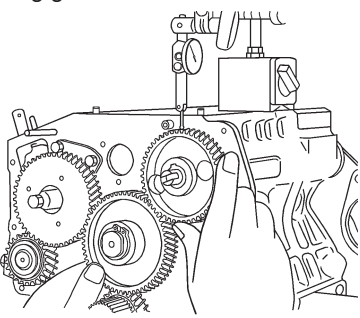
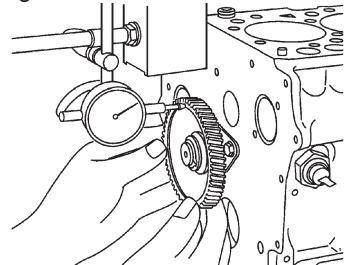
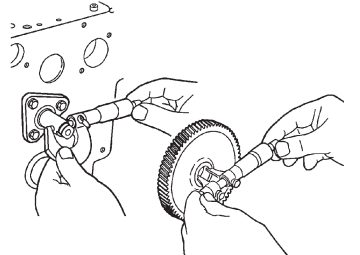
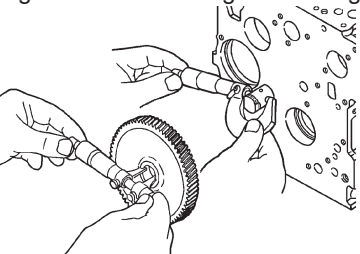
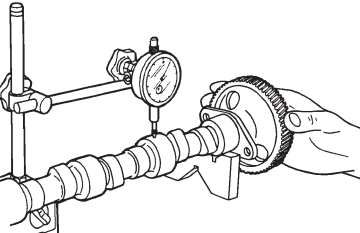
Item			Factory Specification	Allowable Limit
 <p>Timing gear</p>	Backlash (Crank gear to idle gear 1)	All models	0.032 to 0.115 mm 0.00126 to 0.00453 in.	0.15 mm 0.0059 in.
	Backlash (Idle gear 1 to cam gear)	All models	0.036 to 0.114 mm 0.00142 to 0.00449 in.	0.15 mm 0.0059 in.
	Backlash (Idle gear 1 to injection pump)	All models	0.034 to 0.116 mm 0.00134 to 0.00457 in.	0.15 mm 0.0059 in.
	Backlash (Injection pump gear to governor gear)	All models	0.030 to 0.117 mm 0.00118 to 0.00461 in.	0.15 mm 0.0059 in.
	Backlash (Idle gear 1 to idle gear 2)	Equipped with idle gear 2	0.033 to 0.117 mm 0.00130 to 0.00461 in.	0.15 mm 0.0059 in.
	Backlash (Idle gear 2 to governor gear)	Equipped with idle gear 2	0.030 to 0.117 mm 0.00118 to 0.00461 in.	0.15 mm 0.0059 in.
 <p>Idle gear</p>	Side clearance (Idle gear 1)	All models	0.20 to 0.51 mm 0.0079 to 0.0201 in.	0.8 mm 0.0315 in.
	Side clearance (Idle gear 2)	Equipped with idle gear 2	0.20 to 0.51 mm 0.0079 to 0.0201 in.	0.8 mm 0.0315 in.
 <p>Idle gear shaft 1 to idle gear bushing</p>	Clearance	All models	0.020 to 0.054 mm 0.00079 to 0.00213 in.	0.1 mm 0.0039 in.
	Idle gear shaft 1 O.D.	All models	25.967 to 25.980 mm 1.02232 to 1.02283 in.	—
	Idle gear bushing I.D.	All models	26.000 to 26.021 mm 1.02362 to 1.02445 in.	—
 <p>Idle gear shaft 2 to idle gear bushing</p>	Clearance	All models	0.020 to 0.054 mm 0.00079 to 0.00213 in.	0.1 mm 0.0039 in.
	Idle gear shaft 2 O.D.	All models	25.967 to 25.980 mm 1.02232 to 1.02283 in.	—
	Idle gear bushing I.D.	All models	26.000 to 26.021 mm 1.02362 to 1.02445 in.	—
 <p>Camshaft</p>	Alignment	All models	—	0.01 mm 0.0004 in.

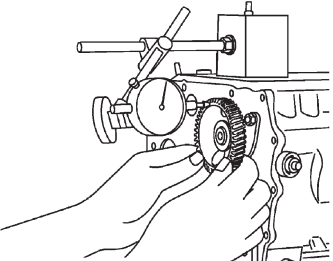
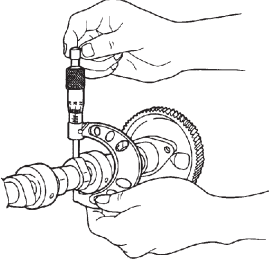
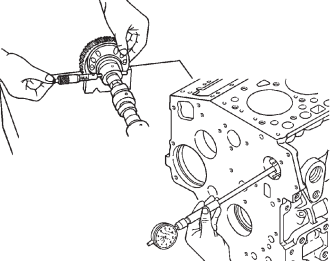
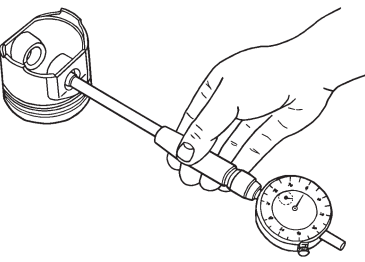
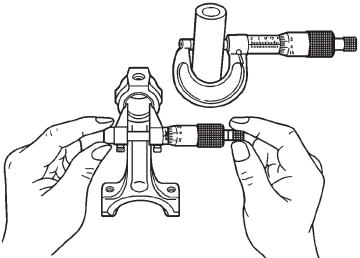
Item		Factory Specification	Allowable Limit
Camshaft 	Side clearance	All models 0.07 to 0.22 mm 0.0028 to 0.0087 in.	0.3 mm 0.0118 in.
	Cam 	Height (Intake)	All models 28.80 mm 1.1339 in.
Camshaft journal to cylinder block bore 	Height (Exhaust)	All models 29.00 mm 1.1417 in.	28.95 mm 1.1398 in.
	Oil clearance	All models 0.050 to 0.091 mm 0.00197 to 0.00358 in.	0.15 mm 0.0059 in.
	Camshaft journal O.D.	All models 35.934 to 35.950 mm 1.41472 to 1.41535 in.	—
Piston pin bore 	Cylinder block bore I.D.	All models 36.000 to 36.025 mm 1.41732 to 1.41830 in.	—
	Piston pin bore I.D.	All models 22.000 to 22.013 mm 0.86614 to 0.86665 in.	22.03 mm 0.8673 in.
Piston pin to small end bushing 	Clearance	All models 0.014 to 0.038 mm 0.00055 to 0.00150 in.	0.15 mm 0.0059 in.
	Piston pin O.D.	All models 22.002 to 22.011 mm 0.86622 to 0.86657 in.	—
	Small end bushing I.D.	All models 22.025 to 22.040 mm 0.86712 to 0.86771 in.	—

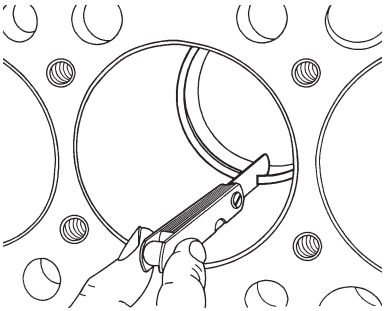
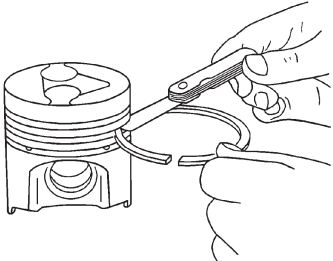
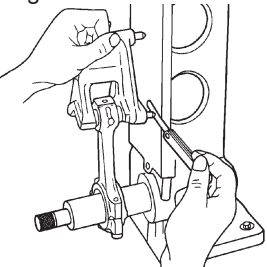
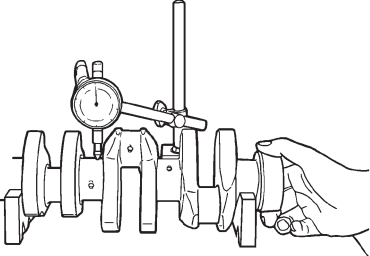
Item			Factory Specification	Allowable Limit
Piston ring 	Ring gap (Top ring)	D905-E2B	0.25 to 0.40 mm 0.0098 to 0.0157 in.	1.25 mm 0.0492 in.
		D1005-E2B D1105-E2B V1305-E2B V1505-E2B	0.30 to 0.45 mm 0.0118 to 0.0177 in.	1.25 mm 0.0492 in.
		D1105-T-E2B V1505-T-E2B	0.20 to 0.35 mm 0.0079 to 0.0138 in.	1.20 mm 0.0472 in.
	Ring gap (Second ring)	D905-E2B	0.25 to 0.40 mm 0.0098 to 0.0157 in.	1.25 mm 0.0492 in.
		D1005-E2B D1105-E2B V1305-E2B V1505-E2B	0.30 to 0.45 mm 0.0118 to 0.0177 in.	1.25 mm 0.0492 in.
		D1105-T-E2B V1505-T-E2B	0.40 to 0.55 mm 0.0157 to 0.0217 in.	1.20 mm 0.0472 in.
Ring gap (Oil ring)	D905-E2B D1005-E2B D1105-E2B V1305-E2B V1505-E2B	0.25 to 0.40 mm 0.0098 to 0.0157 in.	1.25 mm 0.0492 in.	
	D1105-T-E2B V1505-T-E2B	0.30 to 0.55 mm 0.0118 to 0.0217 in.	1.25 mm 0.0492 in.	
Piston ring groove to piston ring 	Clearance (Second ring)	All models	0.085 to 0.112 mm 0.00335 to 0.00441 in.	0.20 mm 0.0079 in.
	Clearance (Oil ring)	All models	0.020 to 0.055 mm 0.00079 to 0.00217 in.	0.15 mm 0.0059 in.
Connecting rod 	Alignment	All models	—	0.05 mm 0.0020 in.
Crankshaft 	Alignment	All models	—	0.02 mm 0.0008 in.

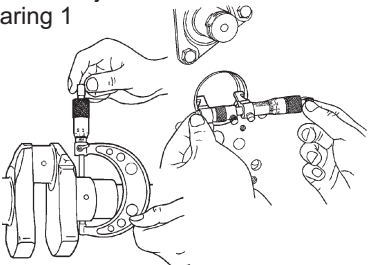
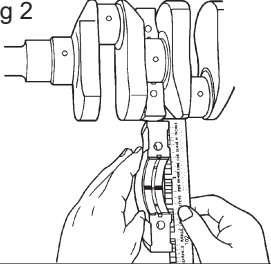
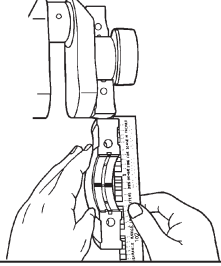
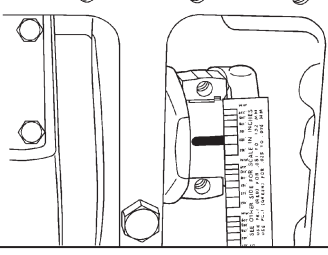
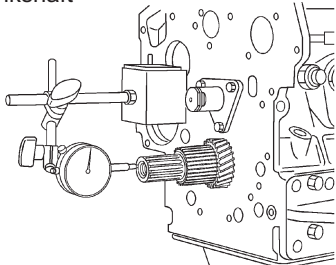
Item			Factory Specification	Allowable Limit
Crankshaft journal to crankshaft bearing 1 	Oil clearance	All models	0.034 to 0.114 mm 0.00134 to 0.00449 in.	0.2 mm 0.0079 in.
	Crankshaft journal O.D.	All models	47.934 to 47.950 mm 1.88716 to 1.88779 in.	—
	Crankshaft bearing 1 I.D.	All models	47.984 to 48.048 mm 1.88913 to 1.89165 in.	—
Crankshaft journal to crankshaft bearing 2 	Oil clearance	All models	0.034 to 0.095 mm 0.00134 to 0.00374 in.	0.2 mm 0.0079 in.
	Crankshaft journal O.D.	All models	47.934 to 47.950 mm 1.88716 to 1.88779 in.	—
	Crankshaft bearing 2 I.D.	All models	47.984 to 48.029 mm 1.88913 to 1.89090 in.	—
Crankshaft journal to crankshaft bearing 3 	Oil clearance	All models	0.034 to 0.098 mm 0.00134 to 0.00386 in.	0.2 mm 0.0079 in.
	Crankshaft journal O.D.	All models	51.921 to 51.940 mm 2.04413 to 2.04488 in.	—
	Crankshaft bearing 3 I.D.	All models	51.974 to 52.019 mm 2.04622 to 2.04799 in.	—
Crankpin to crankpin bearing 	Oil clearance	All models	0.029 to 0.091 mm 0.00114 to 0.00358 in.	0.2 mm 0.0079 in.
	Crankpin O.D.	All models	39.959 to 39.975 mm 1.57319 to 1.57382 in.	—
	Crankpin bearing I.D.	All models	40.004 to 40.050 mm 1.57496 to 1.57677 in.	—
Crankshaft 	Side clearance	All models	0.15 to 0.31 mm 0.0059 to 0.0122 in.	0.5 mm 0.0197 in.

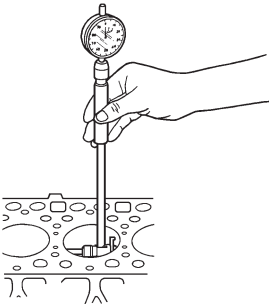
Item		Factory Specification	Allowable Limit
Cylinder 	Bore I.D. (Standard size)	D905-E2B 72.000 to 72.019 mm 2.83464 to 2.83539 in.	72.169 mm 2.84129 in.
		D1005-E2B V1305-E2B 76.000 to 76.019 mm 2.99212 to 2.99287 in.	76.169 mm 2.99877 in.
		D1105-E2B D1105-T-E2B V1505-E2B V1505-T-E2B 78.000 to 78.019 mm 3.07086 to 3.07161 in.	78.169 mm 3.07751 in.
	Bore I.D. (Oversize)	D905-E2B 72.500 to 72.519 mm 2.85433 to 2.85507 in.	72.669 mm 2.86098 in.
		D1005-E2B V1305-E2B 76.500 to 76.519 mm 3.01181 to 3.01255 in.	76.669 mm 3.01846 in.
		D1105-E2B D1105-T-E2B V1505-E2B V1505-T-E2B 78.5000 to 78.519 mm 3.09055 to 3.09129 in.	78.669 mm 3.09720 in.

(2) LUBRICATING SYSTEM

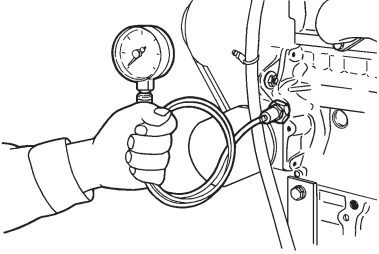
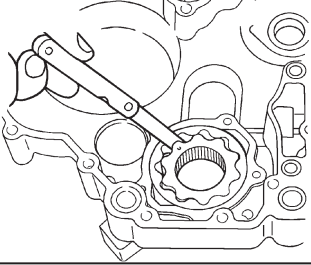
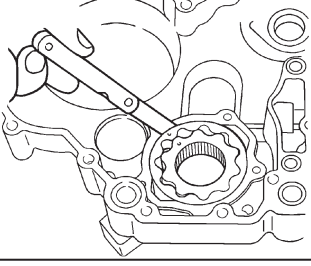
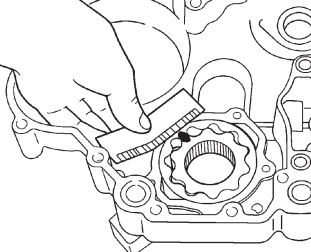
Item		Factory Specification	Allowable Limit
Engine oil pressure 	Engine oil pressure (At idle speed) All models	—	49 kPa 0.5 kgf/cm ² 7 psi
	Engine oil pressure (At rated speed) All models	196 to 441 kPa 2.0 to 4.5 kgf/cm ² 28 to 64 psi	147 kPa 1.5 kgf/cm ² 21 psi
Inner rotor to outer rotor (Oil pump) 	Clearance All models	0.06 to 0.18 mm 0.0024 to 0.0071 in.	—
Outer rotor to pump body (Oil pump) 	Clearance All models	0.10 to 0.18 mm 0.0039 to 0.0071 in.	—
Inner rotor to cover (Oil pump) 	Clearance All models	0.025 to 0.075 mm 0.00098 to 0.00295 in.	—

(3) COOLING SYSTEM

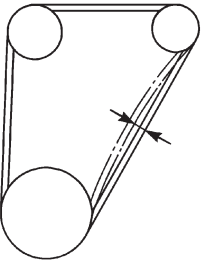
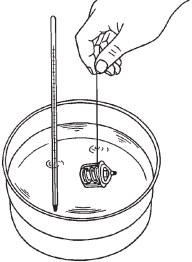
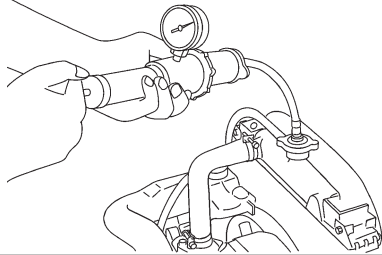
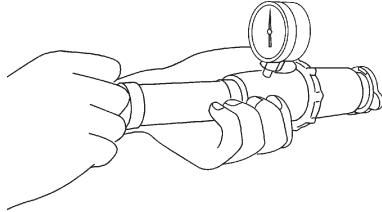
Item			Factory Specification	Allowable Limit
Fan belt 	Tension	All models	7.0 to 9.0 mm (0.28 to 0.35 in.) deflection at 98 N (10 kgf, 22 lbs) of force	—
Thermostat 	Valve opening temperature (At beginning)	All models	69.5 to 72.5 °C 157.1 to 162.5 °F	—
	Valve opening temperature (Opened completely)	All models	85 °C 185 °F	—
Radiator 	Water tightness	All models	No water leak at 137 kPa 1.4 kgf/cm ² 20 psi	—
Radiator cap 	Pressure falling time	All models	10 seconds or more for pressure falling from 88 to 59 kPa (from 0.9 to 0.6 kgf/cm ² , from 13 to 9 psi)	—

(4) FUEL SYSTEM

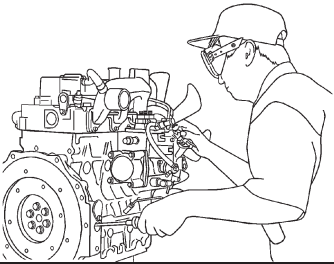
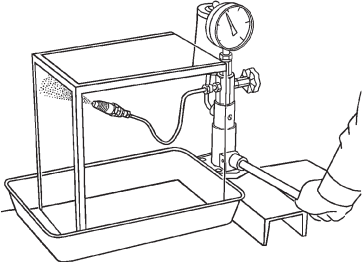
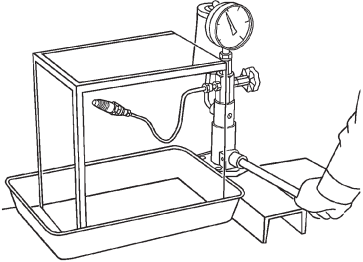
Item		Factory Specification	Allowable Limit
Injection pump 	Injection timing	Rated revolution : 3000 min^{-1} (rpm) 0.30 to 0.33 rad. before T.D.C. 17 to 19° before T.D.C.	—
		Rated revolution : 3600 min^{-1} (rpm) 0.35 to 0.39 rad. before T.D.C. 20 to 22° before T.D.C.	—
Injection nozzle 	Injection pressure	All models 13.7 to 14.7 MPa 140 to 150 kgf/cm ² 1991 to 2133 psi	—
Injection nozzle 	Valve seat tightness	All models No fuel leak at 12.75 MPa 130 kgf/cm ² 1849 psi	—

(5) ELECTRICAL SYSTEM

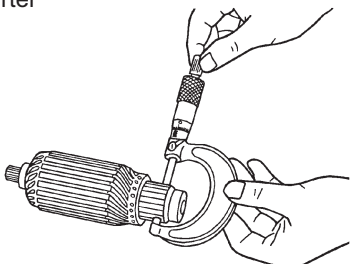
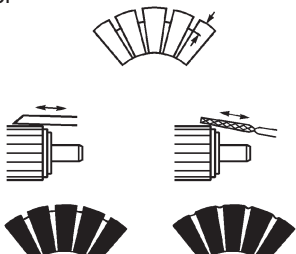
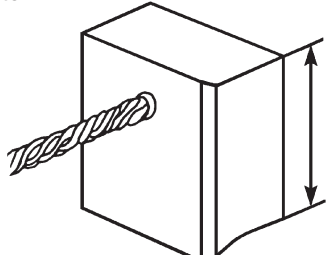
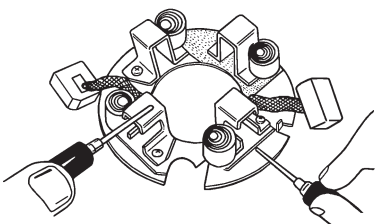
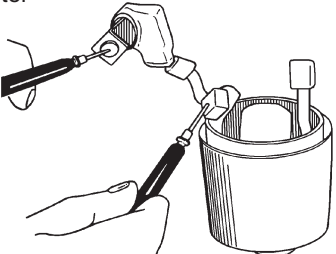
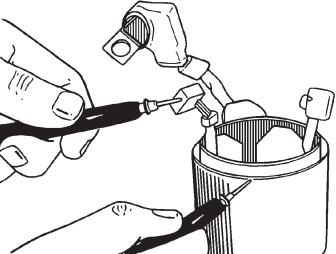
Item			Factory Specification	Allowable Limit
Starter 	Commutator O.D.	All models	30.0 mm 1.181 in	29.0 mm 1.142 in.
Starter 	Mica under cut	All models	0.50 to 0.80 mm 0.0197 to 0.0315 in.	0.20 mm 0.0079 in.
Starter 	Brush length	All models	13.0 mm 0.5118 in.	8.5 mm 0.3346 in.
Starter 	Brush holder resistance (Brush holder - Holder support)	All models	Infinity	—
Starter 	Field coil resistance (Lead - Brush)	All models	Continuity	—
Starter 	Field coil resistance (Brush - Yoke)	All models	Infinity	—

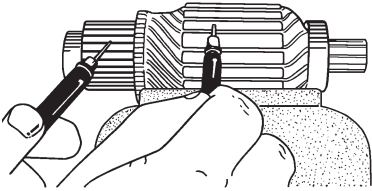
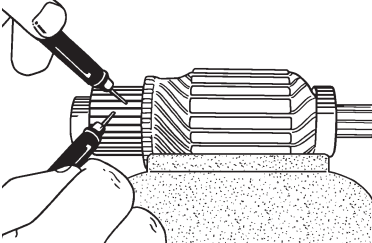
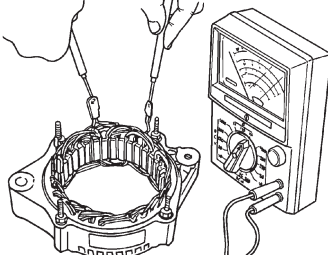
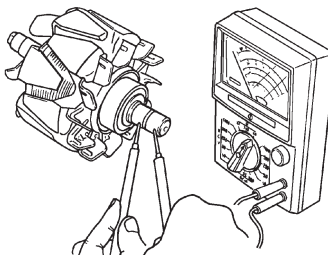
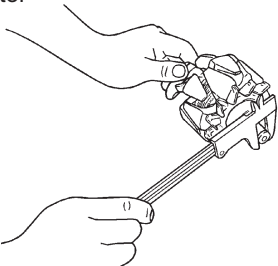
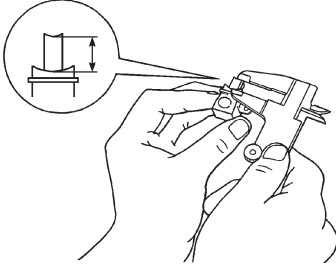
Item			Factory Specification	Allowable Limit
Starter 	Armature coil resistance (Commutator - Armature coil core)	All models	Infinity	—
Starter 	Armature coil resistance (Segment - Segment)	All models	Continuity	—
Alternator 	Stator resistance	All models	Less than 1.0 Ω	—
Alternator 	Rotor resistance	All models	2.9 Ω	—
Alternator 	Slip ring O.D.	All models	14.4 mm 0.567 in.	14.0 mm 0.551 in.
Alternator 	Brush length	All models	10.0 mm 0.3937 in.	1.5 mm 0.0591 in.

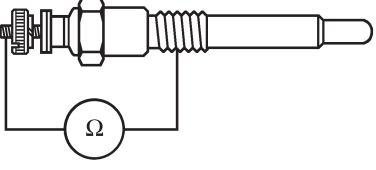
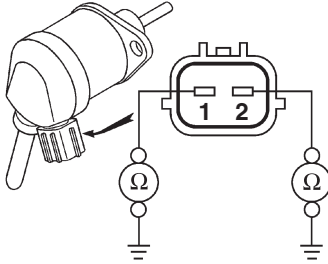
Item			Factory Specification	Allowable Limit
Glow plug 	Resistance	All models	Approx. 0.9 Ω	—
Stop solenoid 	Resistance (Terminal 1 - body)	All models	Approx. 0.38 Ω	—
	Resistance (Terminal 2 - body)	All models	Approx. 15.58 Ω	—

TIGHTENING TORQUES

(1) Special Tightening Torques

For "*" marked screws, bolts and nuts on under table, apply engine oil to their threads and seats before tightening.

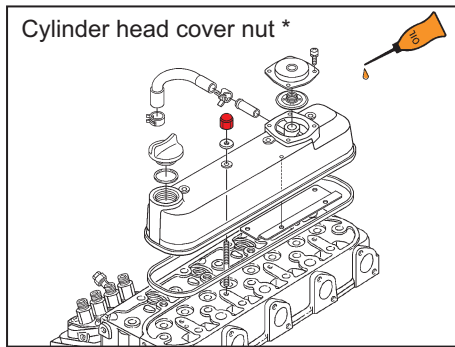

Cylinder head cover nut *

D905-E2B	
D1005-E2B	
D1105-E2B	6.9 to 8.8 N·m
D1105-T-E2B	0.7 to 0.9 kgf·m
V1305-E2B	5.1 to 6.5 ft-lbs
V1505-E2B	
V1505-T-E2B	

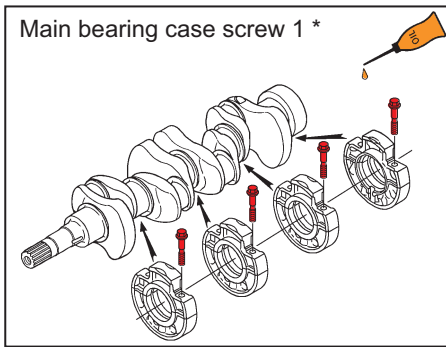

Main bearing case screw 1 *

D905-E2B	
D1005-E2B	
D1105-E2B	29.4 to 34.3 N·m
D1105-T-E2B	3.0 to 3.5 kgf·m
V1305-E2B	21.7 to 25.3 ft-lbs
V1505-E2B	
V1505-T-E2B	

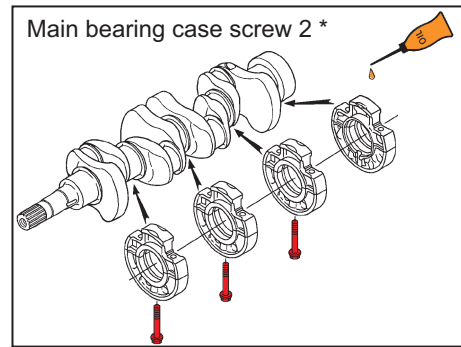

Main bearing case screw 2 *

D905-E2B	
D1005-E2B	
D1105-E2B	49.0 to 53.9 N·m
D1105-T-E2B	5.0 to 5.5 kgf·m
V1305-E2B	36.2 to 39.8 ft-lbs
V1505-E2B	
V1505-T-E2B	

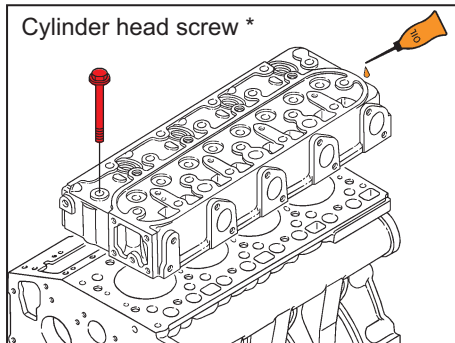

Cylinder head screw *

D905-E2B	
D1005-E2B	
D1105-E2B	63.7 to 68.6 N·m
D1105-T-E2B	6.5 to 7.0 kgf·m
V1305-E2B	47.0 to 50.6 ft-lbs
V1505-E2B	
V1505-T-E2B	

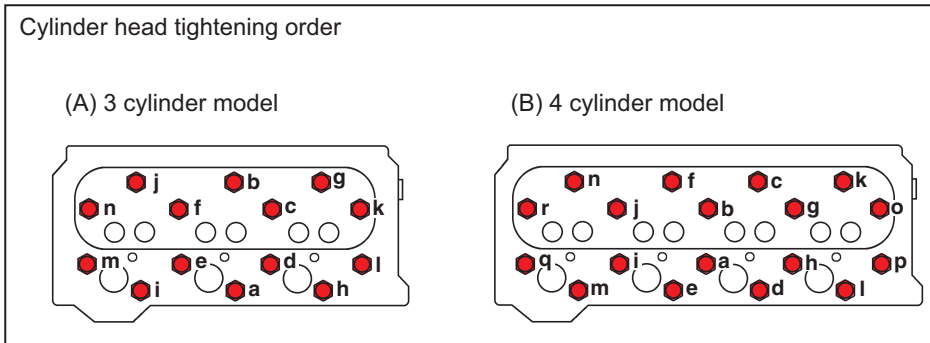

Cylinder head tightening order

D905-E2B	
D1005-E2B	
D1105-E2B	(A) 3 cylinder model
D1105-T-E2B	a → n
V1305-E2B	(B) 4 cylinder model
V1505-E2B	a → r
V1505-T-E2B	

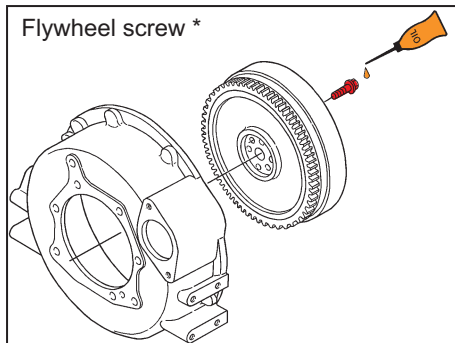

Flywheel screw *

D905-E2B	
D1005-E2B	
D1105-E2B	53.9 to 58.8 N·m
D1105-T-E2B	5.5 to 6.0 kgf·m
V1305-E2B	39.8 to 43.4 ft-lbs
V1505-E2B	
V1505-T-E2B	

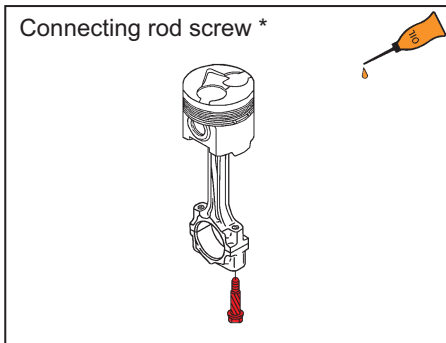

Connecting rod screw *

D905-E2B	
D1005-E2B	
D1105-E2B	41.2 to 46.1 N·m
D1105-T-E2B	4.2 to 4.7 kgf·m
V1305-E2B	30.4 to 34.0 ft-lbs
V1505-E2B	
V1505-T-E2B	

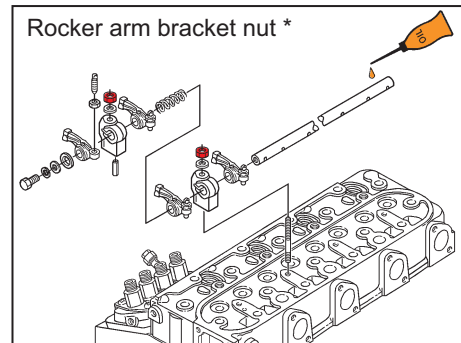

Rocker arm bracket nut *

D905-E2B	
D1005-E2B	
D1105-E2B	21.6 to 26.5 N·m
D1105-T-E2B	2.2 to 2.7 kgf·m
V1305-E2B	15.9 to 19.5 ft-lbs
V1505-E2B	
V1505-T-E2B	

Idle gear shaft screw *

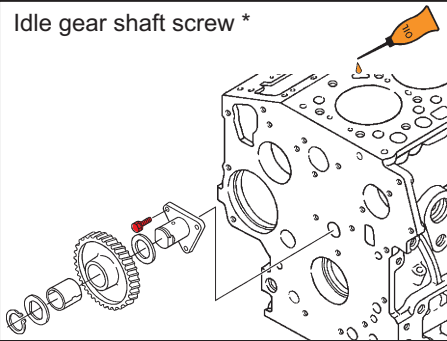

D905-E2B	
D1005-E2B	
D1105-E2B	9.8 to 11.3 N·m
D1105-T-E2B	1.00 to 1.15 kgf·m
V1305-E2B	7.2 to 8.3 ft-lbs
V1505-E2B	
V1505-T-E2B	

Bearing case cover screw *

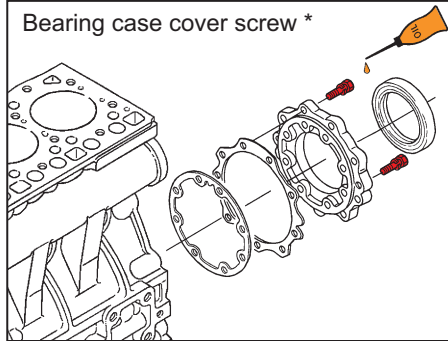

D905-E2B	
D1005-E2B	
D1105-E2B	9.8 to 11.3 N·m
D1105-T-E2B	1.00 to 1.15 kgf·m
V1305-E2B	7.2 to 8.3 ft-lbs
V1505-E2B	
V1505-T-E2B	

Fan drive pulley screw

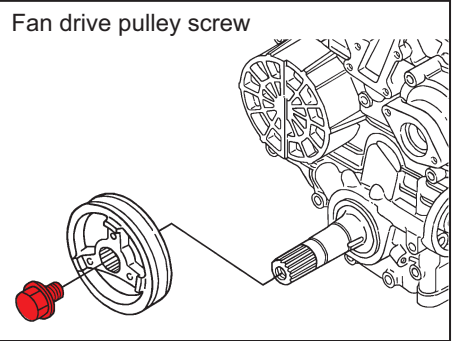

D905-E2B	
D1005-E2B	
D1105-E2B	235.4 to 245.2 N·m
D1105-T-E2B	24.0 to 25.0 kgf·m
V1305-E2B	173.6 to 180.8 ft-lbs
V1505-E2B	
V1505-T-E2B	

Glow plug

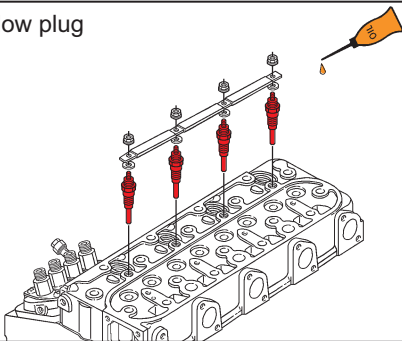

D905-E2B	
D1005-E2B	
D1105-E2B	7.8 to 14.7 N·m
D1105-T-E2B	0.8 to 1.5 kgf·m
V1305-E2B	5.8 to 10.8 ft-lbs
V1505-E2B	
V1505-T-E2B	

Nozzle holder assembly

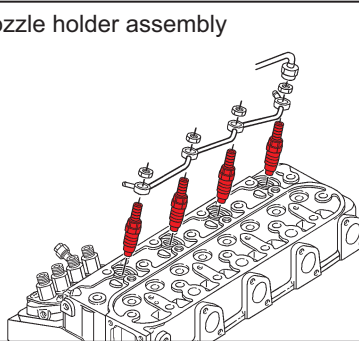

D905-E2B	
D1005-E2B	
D1105-E2B	49.0 to 68.6 N·m
D1105-T-E2B	5.0 to 7.0 kgf·m
V1305-E2B	36.2 to 50.6 ft-lbs
V1505-E2B	
V1505-T-E2B	

Oil switch taper screw

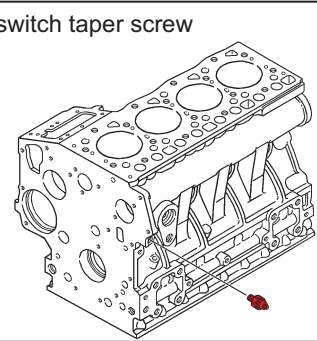

D905-E2B	
D1005-E2B	
D1105-E2B	14.7 to 19.6 N·m
D1105-T-E2B	1.5 to 2.0 kgf·m
V1305-E2B	10.8 to 14.5 ft-lbs
V1505-E2B	
V1505-T-E2B	

Injection pipe retaining nut

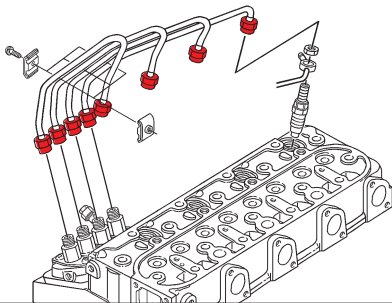

D905-E2B	
D1005-E2B	
D1105-E2B	24.5 to 34.3 N·m
D1105-T-E2B	2.5 to 3.5 kgf·m
V1305-E2B	18.1 to 25.3 ft-lbs
V1505-E2B	
V1505-T-E2B	

Overflow pipe assembly retaining nut

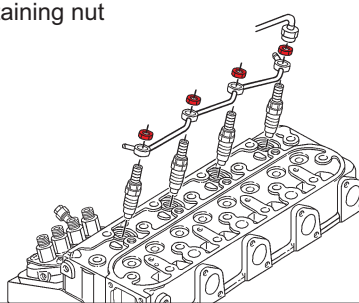

D905-E2B	
D1005-E2B	
D1105-E2B	19.6 to 24.5 N·m
D1105-T-E2B	2.0 to 2.5 kgf·m
V1305-E2B	14.5 to 18.1 ft-lbs
V1505-E2B	
V1505-T-E2B	

Camshaft set screw

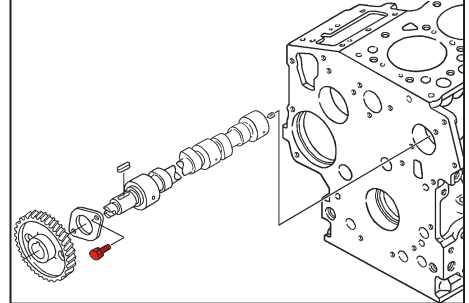

D905-E2B	
D1005-E2B	
D1105-E2B	23.5 to 27.5 N·m
D1105-T-E2B	2.4 to 2.8 kgf·m
V1305-E2B	17.4 to 20.3 ft-lbs
V1505-E2B	
V1505-T-E2B	

Alternator pulley nut

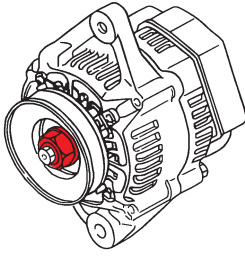

D905-E2B	
D1005-E2B	
D1105-E2B	58.3 to 78.9 N·m
D1105-T-E2B	5.95 to 8.05 kgf·m
V1305-E2B	43.0 to 58.2 ft-lbs
V1505-E2B	
V1505-T-E2B	

(2) General Tightening Torques

Screw and bolt material grades are shown by numbers punched on the screw and bolt heads.

Prior to tightening, be sure to check out the numbers as shown below.

None or 4 : Standard grade

7 : Special grade

Nominal Diameter	Standard Grade	Special Grade
M6	7.9 to 9.3 N·m 0.80 to 0.95 kgf·m 5.8 to 6.9 ft-lbs	9.8 to 11.3 N·m 1.00 to 1.15 kgf·m 7.23 to 8.32 ft-lbs
M8	17.7 to 20.6 N·m 1.8 to 2.1 kgf·m 13.0 to 15.2 ft-lbs	23.5 to 27.5 N·m 2.4 to 2.8 kgf·m 17.4 to 20.3 ft-lbs
M10	39.2 to 45.1 N·m 4.0 to 4.6 kgf·m 28.9 to 33.3 ft-lbs	48.1 to 55.9 N·m 4.9 to 5.7 kgf·m 35.4 to 41.2 ft-lbs
M12	62.8 to 72.6 N·m 6.4 to 7.4 kgf·m 46.3 to 53.5 ft-lbs	77.5 to 90.2 N·m 7.9 to 9.2 kgf·m 57.1 to 66.5 ft-lbs