

**COMPLEX SOLUTIONS  
MADE SIMPLE.**



**DEEP SEA ELECTRONICS PLC  
DSE710  
AUTOSTART CONTROL MODULE  
OPERATING MANUAL**



Deep Sea Electronics Plc  
Highfield House  
Hunmanby  
North Yorkshire  
YO14 0PH  
ENGLAND

Sales Tel: +44 (0) 1723 890099  
Sales Fax: +44 (0) 1723 893303

E-mail: [sales@Deepseapl.com](mailto:sales@Deepseapl.com)  
Website: [www.deepseapl.com](http://www.deepseapl.com)

DSE Model 710 Control and Instrumentation System Operators Manual

© Deep Sea Electronics Plc

All rights reserved. No part of this publication may be reproduced in any material form (including photocopying or storing in any medium by electronic means or other) without the written permission of the copyright holder except in accordance with the provisions of the Copyright, Designs and Patents Act 1988.

Applications for the copyright holder's written permission to reproduce any part of this publication should be addressed to Deep Sea Electronics Plc at the address above.

Any reference to trademarked product names used within this publication is owned by their respective companies.

Deep Sea Electronics Plc reserves the right to change the contents of this document without prior notice.

**TABLE OF CONTENTS**

**1 INTRODUCTION ..... 4**

**2 CLARIFICATION OF NOTATION USED WITHIN THIS PUBLICATION. .... 4**

**3 OPERATION ..... 5**

    3.1 MANUAL OPERATION.....6

    3.2 AUTOMATIC OPERATION.....7

    3.3 PROTECTIONS.....8

    3.4 WARNINGS.....8

    3.5 SHUTDOWNS .....9

**4 FRONT PANEL CONFIGURATION..... 10**

    4.1 ACCESSING THE FRONT PANEL CONFIGURATION EDITOR .....10

**5 INSTALLATION INSTRUCTIONS ..... 17**

    5.1 PANEL CUTOUT .....17

    5.2 CABLE GUIDES .....17

    5.3 COOLING .....17

    5.4 UNIT DIMENSIONS AND REAR PANEL LAYOUT .....18

    5.5 FRONT PANEL LAYOUT .....18

**6 ELECTRICAL CONNECTIONS ..... 19**

    6.1 CONNECTION DETAILS .....19

        6.1.1 CONNECTOR A.....19

        6.1.2 CONNECTOR B.....20

        6.1.3 CONNECTOR C.....20

    6.2 ORDERING REPLACEMENT CONNECTORS FROM DSE.....20

**7 SPECIFICATION..... 21**

**8 COMMISSIONING..... 22**

    8.1 PRE-COMMISSIONING .....22

**9 FAULT FINDING ..... 23**

**10 TYPICAL WIRING DIAGRAM..... 24**

**11 SOLID STATE OUTPUTS..... 25**

## 1 INTRODUCTION

The **DSE 710** remote start module has been primarily designed to control a generator, starting the engine automatically upon receipt of a start signal, transferring the load automatically to the generator if required. If required the generator can be started and stopped manually.

The **DSE 710** monitors the engine, indicating that the generator is running via an LED. An LCD display is used to indicate further status and alarm conditions. When a fault is detected the generator is automatically shut down, giving a true first up fault condition.

Using the module's front panel configuration editor it is possible to alter selective operational sequences, timers and alarm trips. Comprehensive configuration and monitoring is also available using the 700 series PC configuration software for Windows™.

The module is housed in a fully enclosed robust plastic case for front panel mounting, offering a high IP rating of 56 with the optional gasket. Connections to the module are via locking plug and sockets.

## 2 CLARIFICATION OF NOTATION USED WITHIN THIS PUBLICATION.

 <b>NOTE:</b>	Highlights an essential element of a procedure to ensure correctness.
 <b>CAUTION!</b>	Indicates a procedure or practice which, if not strictly observed, could result in damage or destruction of equipment.
 <b>WARNING!</b>	Indicates a procedure or practice, which could result in injury to personnel or loss of life if not followed correctly.
©	Deep Sea Electronics Plc owns the copyright to this manual, which cannot be copied, reproduced or disclosed to a third party without prior written permission.
	Compliant with BS EN 60950 Low Voltage Directive Compliant with BS EN 50081-2 EMC Directive Compliant with BS EN 50082-2 EMC Directive
	UL Registered Component for USA & Canada

### 3 OPERATION

The following description details the sequences followed by a module containing the standard 'factory configuration'. Always refer to your configuration source for the exact sequences and timers observed by any particular module in the field.

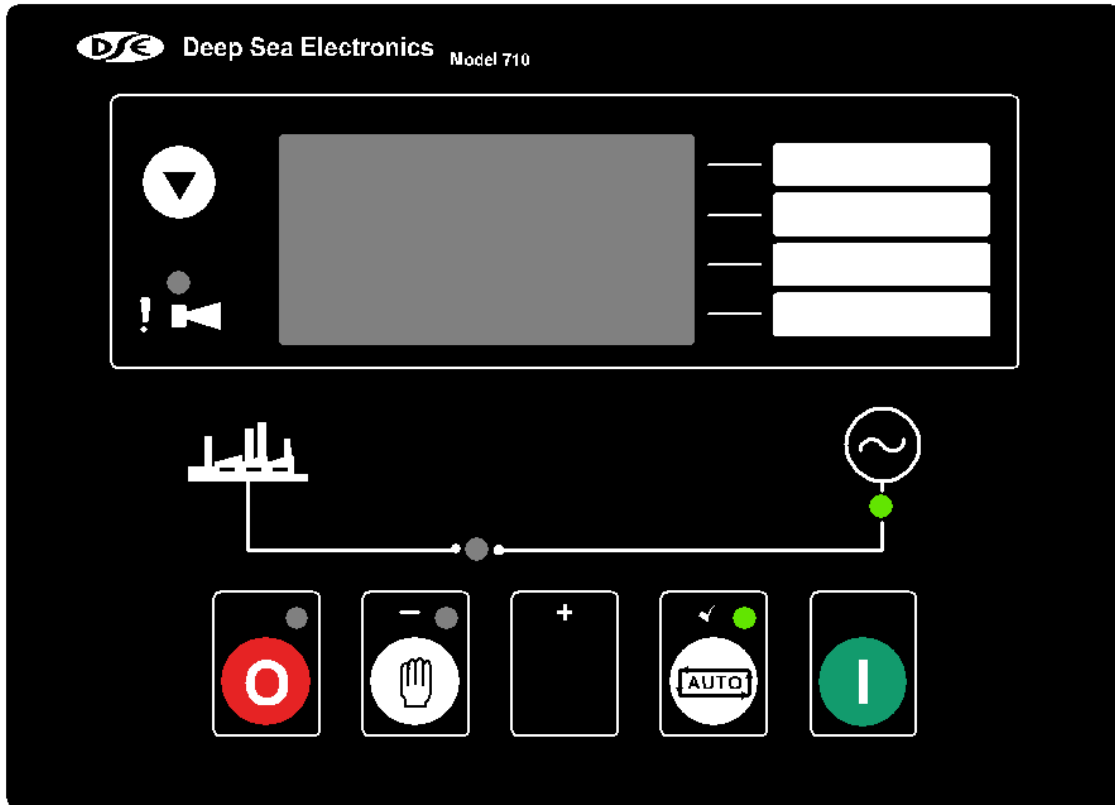

### 3.1 MANUAL OPERATION

This mode is activated by pressing the  pushbutton. An LED indicator beside the button confirms this action.

Press the  button to begin the start sequence.

 **NOTE:- There is no Start Delay in this mode of operation.**

If the **pre-heat** output option is selected this timer is then initiated, and the auxiliary output selected is energised.

After the above delay the **Fuel Solenoid** is energised, then the **Starter Motor** is engaged.

The engine is cranked for a configurable period. If the engine fails to fire during this cranking attempt then the starter motor is disengaged for the configurable rest period. Should this sequence continue beyond the 3 cranking attempts, the start sequence will be terminated and **Fail to Start**  fault will be displayed.

When the engine fires, the starter motor is disengaged and locked out at 20Hz measured from the Alternator output.

After the starter motor has disengaged, the **Safety On** delay is activated. 'Delayed' alarms (underspeed, low oil pressure etc) will be monitored after the end of the Safety On delay.

The generator will run off load, unless the **Remote Start on load** signal is applied, at which point the load will be transferred to the generator so long as the **Warmup Timer** (if configured) has expired.

The generator will continue to run on load regardless of the state of the remote start input until the **Auto** mode is selected.

If Auto mode is selected with the remote start on load signal not active, then the **Remote Stop Delay Timer** begins, after which, the load switch is opened. The generator will then run **off** load allowing the engine a **cooling** down period.

Selecting **STOP (O)** de-energises the **FUEL SOLENOID**, bringing the generator to a stop.

### 3.2 AUTOMATIC OPERATION

This mode is activated by pressing the  pushbutton. An LED indicator beside the button confirms this action.

Should the remote start input be activated, the following sequence is followed :

To allow for false remote start signals, the Start Delay timer is initiated. After this delay, if the pre-heat output option is selected then the pre-heat timer is initiated, and the corresponding auxiliary output (if configured) will energise.

**NOTE:- If the Remote Start signal is removed during the Start Delay timer, the unit will return to a stand-by state.**

After the above delays the **Fuel Solenoid** is energised, then ½ second later, the **Starter Motor** is engaged.

The engine is cranked for a configurable period. If the engine fails to fire during this cranking attempt then the starter motor is disengaged for the configurable rest period. Should this sequence continue beyond the 3 cranking attempts, the start sequence will be terminated and **Fail to Start**

 fault will be displayed.

When the engine fires, the starter motor is disengaged and locked out at 20Hz measured from the Alternator output.

After the starter motor has disengaged, the **Safety On** delay is activated.

'Delayed' alarms (underspeed, low oil pressure etc) will be monitored after the end of the Safety On delay.

The **Warmup timer** (if configured) is then followed.

**NOTE:- The set will not be allowed to load until all delayed alarms indicate "normal" operation. This prevents excessive wear on the damage that could be caused by loading an engine with low oil pressure.**

The load will be transferred to the generator.

Upon removal of the **Remote Start**, the **Stop** delay timer is initiated. Once it has timed out, the load switch is opened. The **Cooling** timer is then initiated, allowing the engine a cooling down period off load before shutting down. Once the **Cooling** timer expires, the **Fuel Solenoid** is de-energised, bringing the generator to a stop.

Should the **Remote Start** signal be re-activated during the cooling down period, the load will be immediately transferred to the generator.

Selecting **STOP (O)** de-energises the **FUEL SOLENOID**, bringing the generator to a stop.

### 3.3 PROTECTIONS

The module will indicate that an alarm has occurred by illuminating the relevant LED.

### 3.4 WARNINGS

Warnings are used to warn the operator of an impending fault but the engine continues to run.

**BATTERY CHARGE FAILURE**, if the module does not detect a voltage from the warning light terminal on the auxiliary charge alternator, the  icon will illuminate. (Either 8 Volts or 16 Volts depending on the configuration of **Nominal DC Voltage**).

**LOW PLANT BATTERY ALARM** The module's DC supply is monitored and if it falls below the configurable level an alarm is generated and the  icon will illuminate.

**INPUTS 1 AND 2** can be configured as warnings or shutdowns. The relevant icon will be illuminated when the input is active.



The item is indication only (not an alarm). For instance this could indicate "System in Auto"

The item has generated a Warning alarm condition.



### 3.5 SHUTDOWNS

Shutdowns are latching and stop the Generator. The alarm must be cleared, and the fault removed to reset the module. In the event of a shutdown the appropriate icon will be illuminated

**▲NOTE:- The alarm condition must be rectified before a reset will take place. If the alarm condition remains it will not be possible to reset the unit (The exception to this is the Low Oil Pressure alarm and similar 'delayed alarms', as the oil pressure will be low with the engine at rest). Any subsequent warnings or shutdowns that occur will be displayed steady, therefore only the first-up shutdown will appear flashing.**

**FAIL TO START**, if the engine does not fire after the pre-set 3 attempts at starting, a shutdown will be initiated.

The  icon will illuminate.

**LOW OIL PRESSURE**, if the module detects that the engine oil pressure has fallen below the low oil pressure setting after the **Safety On** timer has expired, a shutdown will occur.

The  icon will illuminate.

**HIGH ENGINE TEMPERATURE** if the module detects that the engine coolant temperature has exceeded the high engine temperature setting after the **Safety On** timer has expired, a shutdown will occur.

The  icon will illuminate.

**OVERSPEED / OVERFREQUENCY**, if the engine speed exceeds the pre-set trip a shutdown is initiated. Overspeed is not delayed, it is an **immediate shutdown**.

The  icon will illuminate.

**▲NOTE:- During the start-up sequence the overspeed trip level is extended to 24% above the normal frequency for the duration of the safety timer to allow an extra trip level margin. This is used to prevent nuisance tripping on start-up.**

**UNDERSPEED / UNDERFREQUENCY**, if the engine speed falls below the pre-set trip after the **Safety On** timer has expired, a shutdown is initiated.

The  icon will illuminate.

**INPUTS 1 AND 2** can be configured as warnings or shutdowns. The relevant icon will be illuminated when the input is active.

 The item is indication only (not an alarm). For instance this could indicate "System in Auto"

 (Flashing) The item has generated a Shutdown alarm condition.

**FAILED TO REACH LOADING VOLTAGE**, If the engine fires but the generator fails to reach the loading voltage before the end of the **Safety On** timer a shutdown is initiated.

The  icon will illuminate.

**FAILED TO REACH LOADING FREQUENCY**, If the engine fires but the generator fails to reach the loading frequency before the end of the **Safety On** timer a shutdown is initiated.

The  icon will illuminate.

## 4 FRONT PANEL CONFIGURATION

The **DSE 710** module is fully configurable from the front panel or from the 7xx PC configuration software.

### 4.1 ACCESSING THE FRONT PANEL CONFIGURATION EDITOR

**NOTE:- Configuration mode can ONLY be entered when the module is in the STOP mode and the engine is at rest.**

Press the **DOWN** and **STOP** buttons to enter configuration mode.



The first configurable parameter is displayed. In this example, the Start delay timer (parameter 0) is currently set to 5s.

Parameter  
(Start delay)

Current value  
(5 seconds)

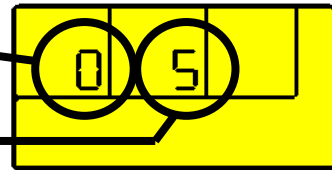

### 4.2 EDITING A PARAMETER

- Enter the editor as described above.
- Press **+ / -** to scroll through the parameters to the one you want to change.
- Press **✓** to enter edit mode. The **↑↓** symbol will flash on the display to indicate that edit mode has been entered.
- Press **+ / -** to change the value to the desired parameter.
- Press **✓** to save the value and exit edit mode for this parameter.
- The **↑↓** symbol will be removed from the display to indicate that edit mode has been exited.
- To select another value to edit, press the **+ / -** buttons. Continuing to press the **+** and **-** buttons will cycle through the adjustable parameters as shown in the following lists.

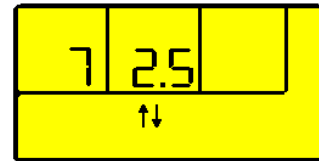

**NOTE: To exit the front panel configuration editor at any time, press the Stop/Reset button.**

**Ensure you have saved any changes you have made by pressing the ✓ button first.**

Parameter	Minimum	Maximum	Default
<b>Timers</b>			
0 - Start Delay	0 secs	60 mins	<b>5 secs</b>
1 - Preheat	0 secs	60 secs	<b>0 secs</b>
2 - Cranking Time	3 secs	60 secs	<b>10 secs</b>
3 - Crank Rest Time	3 secs	60 secs	<b>10 secs</b>
4 - Safety On Delay	8 secs	60 secs	<b>8 secs</b>
5 - Warm Up Time	0 secs	10 mins	<b>0 secs</b>
6 - Frequency Alarm Delay (gen transient delay)	0 secs	10 secs	<b>0 secs</b>
7 - Remote Stop Delay Time	0 secs	60 mins	<b>30 secs</b>
8 - Cooling Time	0 secs	30 mins	<b>1 min</b>
9 - ETS Hold Time	0 secs	60 secs	<b>0 secs</b>
10 - Fail To Stop Delay Time	10 secs	60 secs	<b>60 secs</b>
11 - Low DC Voltage Alarm Delay	0 secs	60 mins	<b>5 mins</b>
<b>Generator</b>			
12 - Under Frequency	0	60Hz	<b>40Hz</b>
13 - Loading Frequency	20Hz	60Hz	<b>47Hz</b>
14 - Over Frequency	50Hz	72Hz	<b>57Hz</b>
15 - Loading Voltage	50V	333V	<b>212V</b>
16 - Over Current Alarm Limit	50%	120%	<b>110%</b>
17 - Over Current Alarm Type	0	2	<b>1</b>
Possible selections	0 - Warning		
	<b>1 - Shutdown</b>		
	2 - Electrical Trip		
<b>Engine</b>			
18 - Low DC Voltage Alarm Limit	0	25V	<b>8V</b>
19 - Charge Fail Voltage Alarm Limit	0V	25V	<b>8V</b>
<b>Input settings</b>			
20 - Low Oil Pressure	5 PSI	150 PSI	<b>15 PSI</b>
21 - High Engine Temperature	90°C	150°C	<b>95°C</b>
22 - Remote Start	0	3	<b>0</b>
Possible selections :	<b>0 - Remote start, close to activate</b>		
	1 - Remote start, open to activate		
23 - Aux Input 1 (see note 5)	0	9	<b>8</b>
Possible selections :	0 - Delayed, warning, close to activate		
	1 - Delayed, warning, open to active		
	2 - Immediate, warning, close to activate		
	3 - Immediate, warning, open to activate		
	4 - Delayed, shutdown, close to activate		
	5 - Delayed, shutdown. Open to activate		
	6 - Immediate, shutdown, close to activate		
	7 - Immediate, shutdown, open to activate		
	<b>8 - Lamp test, close to activate</b>		
	9 - Lamp test, open to activate		
24 - Aux Input 1 delay	0 secs	10.0 secs	<b>0</b>
25 - Aux Input 2 (see note 6)	0	9	<b>0</b>
Possible selections :	<b>0 - Delayed, warning, close to activate</b>		
	1 - Delayed, warning, open to active		
	2 - Immediate, warning, close to activate		
	3 - Immediate, warning, open to activate		
	4 - Delayed, shutdown, close to activate		
	5 - Delayed, shutdown. Open to activate		
	6 - Immediate, shutdown, close to activate		
	7 - Immediate, shutdown, open to activate		
	8 - Electrical trip, close to activate		
	9 - Electrical trip, open to activate		
26 - Aux Input 2 delay	0 sec	10.0 secs	<b>0</b>

Parameter	Minimum	Maximum	Default
<b>Outputs</b>			
27 - Aux Output 1	0	15	1
Possible selections :	0 - Unused		
	<b>1 - Preheat Mode 0</b>		
	2 - Air Flap		
	3 - Close Generator		
	4 - Energise to stop		
	5 - Engine Running		
	6 - Shutdown Alarm		
	7 - System in auto		
	8 - Auxiliary input 1 active		
	9 - Auxiliary input 2 active		
	10 - Preheat mode 1		
	11 - Preheat mode 2		
	12 - Preheat mode 3		
	13 - Warning Alarm		
	14 - Common Alarm		
	15 - Fail to start		
28 - Aux Output 2	0	15	14
Possible selections :	0 - Unused		
	1 - Preheat Mode 0		
	2 - Air Flap		
	3 - Close Generator		
	4 - Energise to stop		
	5 - Engine Running		
	6 - Shutdown Alarm		
	7 - System in auto		
	8 - Auxiliary input 1 active		
	9 - Auxiliary input 2 active		
	10 - Preheat mode 1		
	11 - Preheat mode 2		
	12 - Preheat mode 3		
	13 - Warning Alarm		
	<b>14 - Common Alarm</b>		
	15 - Fail to start		

**▲NOTE:-** The 'preheat modes' selectable for configurable outputs and LCD indicators perform the following actions :

**Preheat mode 0 - Preheat during preheat timer, ceasing at end of preheat timer.**

**Preheat mode 1 - Preheat during preheat timer and continue until engine stops cranking.**

**Preheat mode 2 - Preheat during preheat timer and continue until the safety delay timer has expired.**

**Preheat mode 3 - Preheat during preheat timer and continue until the warming timer has expired.**

**In addition, in all preheat modes, preheat takes place during the crank rest timer between crank cycles.**

Parameter	Minimum	Maximum	Default
<b>Outputs</b>			
29 - Aux Output 3	0	15	<b>3</b>
Possible selections :	0 - Unused		
	1 - Preheat Mode 0		
	2 - Air Flap		
	<b>3 - Close Generator</b>		
	4 - Energise to stop		
	5 - Engine Running		
	6 - Shutdown Alarm		
	7 - System in auto		
	8 - Auxiliary input 1 active		
	9 - Auxiliary input 2 active		
	10 - Preheat mode 1		
	11 - Preheat mode 2		
	12 - Preheat mode 3		
	13 - Warning Alarm		
	14 - Common Alarm		
	15 - Fail to start		
30 - Aux Output 4	0	15	<b>7</b>
Possible selections :	0 - Unused		
	1 - Preheat Mode 0		
	2 - Air Flap		
	3 - Close Generator		
	4 - Energise to stop		
	5 - Engine Running		
	6 - Shutdown Alarm		
	<b>7 - System in auto</b>		
	8 - Auxiliary input 1 active		
	9 - Auxiliary input 2 active		
	10 - Preheat mode 1		
	11 - Preheat mode 2		
	12 - Preheat mode 3		
	13 - Warning Alarm		
	14 - Common Alarm		
	15 - Fail to start		

**▲NOTE:-** The 'preheat modes' selectable for configurable outputs and LCD indicators perform the following actions :

**Preheat mode 0 - Preheat during preheat timer, ceasing at end of preheat timer.**

**Preheat mode 1 - Preheat during preheat timer and continue until engine stops cranking.**

**Preheat mode 2 - Preheat during preheat timer and continue until the safety delay timer has expired.**

**Preheat mode 3 - Preheat during preheat timer and continue until the warming timer has expired.**

**In addition, in all preheat modes, preheat takes place during the crank rest timer between crank cycles.**

Parameter	Minimum	Maximum	Default
<b>LCD Indicators</b>			
31 - LCD indicator 1	0	15	<b>8</b>
Possible selections :	0 - Unused		
	1 - Preheat Mode 0		
	2 - Air Flap		
	3 - Close Generator		
	4 - Energise to stop		
	5 - Engine Running		
	6 - Shutdown Alarm		
	7 - System in auto		
	<b>8 - Auxiliary input 1 active</b>		
	9 - Auxiliary input 2 active		
	10 - Preheat mode 1		
	11 - Preheat mode 2		
	12 - Preheat mode 3		
	13 - Warning Alarm		
	14 - Common Alarm		
	15 - Fail to start		
32 - LCD indicator 2	0	15	<b>9</b>
Possible selections :	0 - Unused		
	1 - Preheat Mode 0		
	2 - Air Flap		
	3 - Close Generator		
	4 - Energise to stop		
	5 - Engine Running		
	6 - Shutdown Alarm		
	7 - System in auto		
	8 - Auxiliary input 1 active		
	<b>9 - Auxiliary input 2 active</b>		
	10 - Preheat mode 1		
	11 - Preheat mode 2		
	12 - Preheat mode 3		
	13 - Warning Alarm		
	14 - Common Alarm		
	15 - Fail to start		

**▲NOTE:-** The 'preheat modes' selectable for configurable outputs and LCD indicators perform the following actions :

**Preheat mode 0 - Preheat during preheat timer, ceasing at end of preheat timer.**

**Preheat mode 1 - Preheat during preheat timer and continue until engine stops cranking.**

**Preheat mode 2 - Preheat during preheat timer and continue until the safety delay timer has expired.**

**Preheat mode 3 - Preheat during preheat timer and continue until the warming timer has expired.**

**In addition, in all preheat modes, preheat takes place during the crank rest timer between crank cycles.**

Parameter	Minimum	Maximum	Default
<b>LCD Indicators</b>			
33 - LCD indicator 3	0	15	0
Possible selections :	<b>0 - Unused</b> 1 - Preheat Mode 0 2 - Air Flap 3 - Close Generator 4 - Energise to stop 5 - Engine Running 6 - Shutdown Alarm 7 - System in auto 8 - Auxiliary input 1 active 9 - Auxiliary input 2 active 10 - Preheat mode 1 11 - Preheat mode 2 12 - Preheat mode 3 13 - Warning Alarm 14 - Common Alarm 15 - Fail to start		
34 - LCD indicator 4	0	15	0
Possible selections :	<b>0 - Unused</b> 1 - Preheat Mode 0 2 - Air Flap 3 - Close Generator 4 - Energise to stop 5 - Engine Running 6 - Shutdown Alarm 7 - System in auto 8 - Auxiliary input 1 active 9 - Auxiliary input 2 active 10 - Preheat mode 1 11 - Preheat mode 2 12 - Preheat mode 3 13 - Warning Alarm 14 - Common Alarm 15 - Fail to start		

**▲NOTE:-** The 'preheat modes' selectable for configurable outputs and LCD indicators perform the following actions :

- Preheat mode 0 - Preheat during preheat timer, ceasing at end of preheat timer.**
- Preheat mode 1 - Preheat during preheat timer and continue until engine stops cranking.**
- Preheat mode 2 - Preheat during preheat timer and continue until the safety delay timer has expired.**
- Preheat mode 3 - Preheat during preheat timer and continue until the warming timer has expired.**

**In addition, in all preheat modes, preheat takes place during the crank rest timer between crank cycles.**

Parameter	Minimum	Maximum	Default
<b>Misc</b>			
35 - Full Load Current Rating	5A	6000A	<b>500A</b>
36 - Current Transformer Primary	5A	6000A	<b>500A</b>
37 - Alternator Poles	2	8	<b>4</b>
38 - AC Topology (see note 1)	0	1	<b>0</b>
Possible selections :	<b>0 - 3 phase, 4 wire</b> 1 - Single phase, 2 wire		
39 - Oil Pressure Display Units	0	1	<b>0</b>
Possible selections :	<b>0 - Bar / PSI</b> 1 - Kpa		
40 - Oil pressure sender type	0 - Not used		
	1 - Digital closed for low oil pressure		
	2 - Digital open for low oil pressure		
	3 - VDO 5 bar		
	<b>4 - VDO 10 bar</b>		
	5 - Datcon 5 bar		
	6 - Datcon 10 bar		
	7 - Datcon 7 bar		
	8 - Murphy 7 bar		
	9 - User configured		
41 - Coolant temperature sender type	0 - Not used		
	1 - Digital closed for high temperature		
	2 - Digital open for high temperature		
	<b>3 - VDO 120°C</b>		
	4 - Datcon high		
	5 - Datcon low		
	6 - Murphy		
	7 - Cummins		
	8 - PT100		
	9 - User configured		



## 5 INSTALLATION INSTRUCTIONS

The model **DSE 710** Module has been designed for front panel mounting. Fixing is by 4 x 4mm screws into the panel fascia.

### 5.1 PANEL CUTOUT

182mm x 137mm (7.17" x 5.39")  
Maximum panel thickness – 8mm (0.3")

In conditions of excessive vibration the module should be mounted on suitable anti-vibration mountings.

### 5.2 CABLE GUIDES

The model 710 has integral cable clamp/guides fitted to the rear of the module. These enable the panel wiring to be tethered to the clamps helping to guide the cables neatly around the panel. The clamps are designed for cable tie attachments and are spaced to match the sticky backed cable tie bases commonly used in this type of application.

 **HINT!:- The cables can be placed in three different positions, above the clamps, between the clamps and below the clamps. In cases where larger gauge cables are used, it may be necessary to run the cables.**

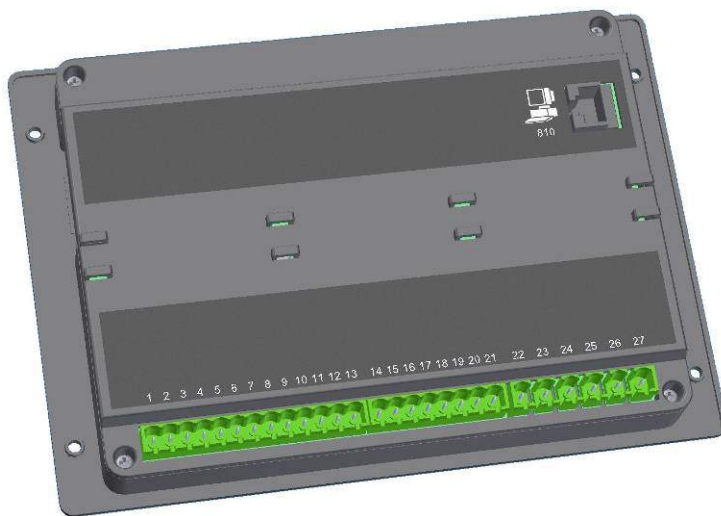

Showing rear view of module without cables

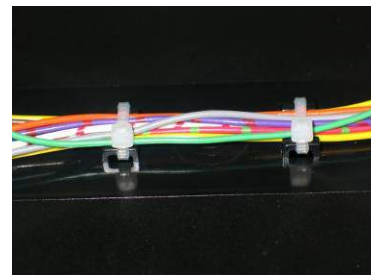

Showing cable between the clamps

### 5.3 COOLING

The module has been designed to operate over a wide temperature range **-30°C to +70°C**. Allowances should be made for the temperature rise within the control panel enclosure. Care should be taken **NOT** to mount possible heat sources near the module unless adequate ventilation is provided. The relative humidity inside the control panel enclosure should not exceed **93%**.

## 5.4 UNIT DIMENSIONS AND REAR PANEL LAYOUT

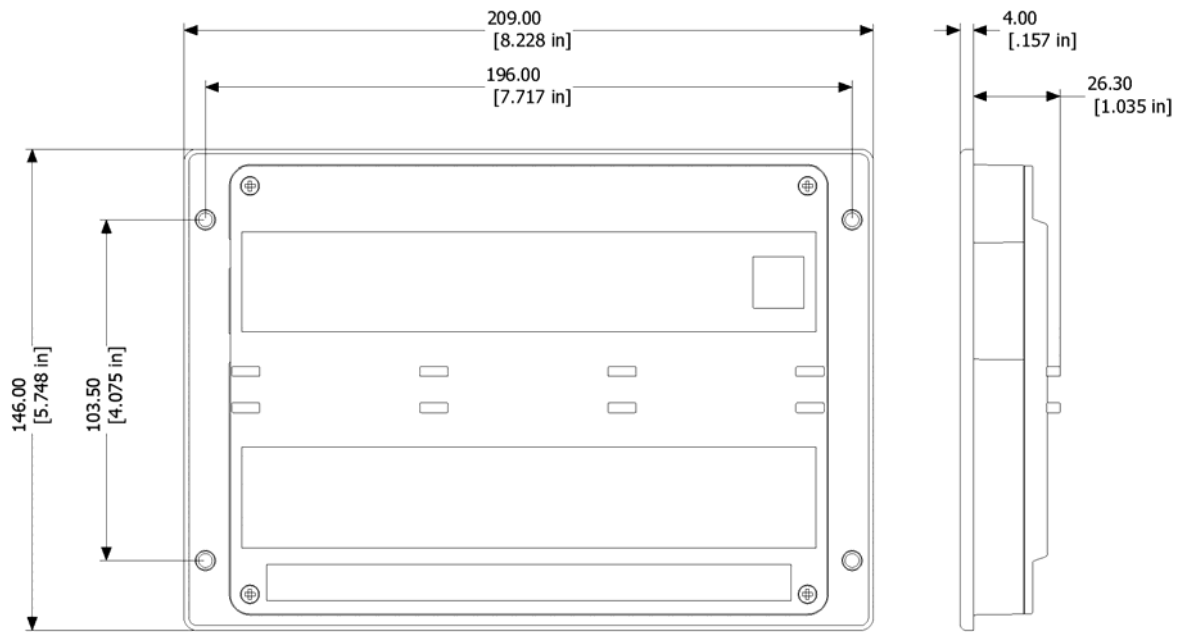

Mounting holes suitable for 4 x 4mm screws

## 5.5 FRONT PANEL LAYOUT

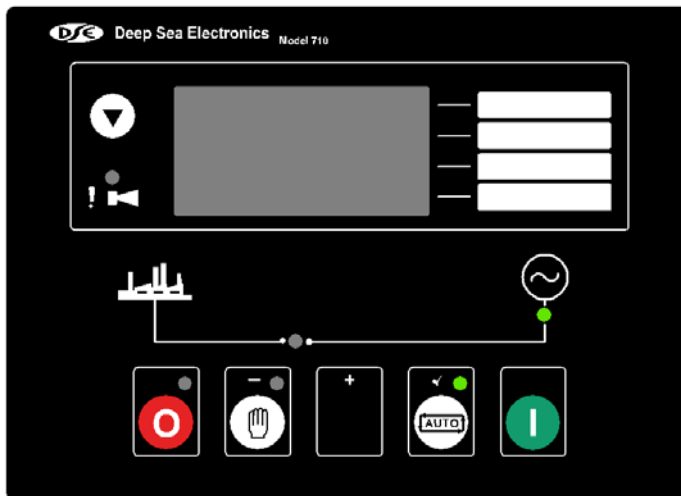

## 6 ELECTRICAL CONNECTIONS

### 6.1 CONNECTION DETAILS

The following describes the connections and recommended cable sizes to the 3 plugs and sockets on the rear of the Module.

Termination at the plug is by screw terminal: Tightening torque 0.8Nm (7 lb-in)

#### 6.1.1 CONNECTOR A

PIN No	DESCRIPTION	CABLE SIZE	NOTES
1	Plant supply negative	2.5mm <sup>2</sup> (13 AWG)	
2	Plant supply positive	2.5mm <sup>2</sup> (13 AWG)	Fuse at 2A anti-surge
3	Emergency stop input	1.0mm <sup>2</sup> (18 AWG)	Switch to battery positive, OPEN to STOP the set.
4	Fuel output	1.0mm <sup>2</sup> (18 AWG)	Connect to Fuel slave relay coil
5	Start output	1.0mm <sup>2</sup> (18 AWG)	Connect to Start slave relay coil
6	Configurable output 1	1.0mm <sup>2</sup> (18 AWG)	
7	Configurable output 2	1.0mm <sup>2</sup> (18 AWG)	
8	Configurable output 3	1.0mm <sup>2</sup> (18 AWG)	
9	Configurable output 4	1.0mm <sup>2</sup> (18 AWG)	
10	Charge Fail / Excite	2.5mm <sup>2</sup> (13 AWG)	Do not connect to ground (battery -ve)
11	LOP input	0.5mm <sup>2</sup> (20 AWG)	Sender / Switch( to plant supply negative) input
12	HET input	0.5mm <sup>2</sup> (20 AWG)	Sender / Switch( to plant supply negative) input
13	Sender/Switch common	0.5mm <sup>2</sup> (20 AWG)	Requires a contact to plant supply negative.

**NOTE:** - Emergency stop input is normally closed to positive, open to STOP the set. If Emergency Stop is not required you must connect a permanent positive signal onto terminal 3.

**NOTE:** - Fuel, Start and the configurable outputs are Solid State Outputs that switch to battery positive when active. See section entitled "Solid State Outputs" elsewhere in this manual for further details.

**NOTE:** - Terminal 13, sender common must be connected to a sound earth at the engine block earth star point. The connection to terminal 13 must not be used for any other purpose.

**NOTE:** - When using switches instead of senders (oil pressure / coolant temp) connect the switch from T13 to the relevant input (T11 = oil press, T12 = coolant temp) AND connect T13 to battery negative.

### 6.1.2 CONNECTOR B

PIN No	DESCRIPTION	CABLE SIZE	NOTES
14	Remote Start input	0.5mm <sup>2</sup> (20 AWG)	Requires a contact to plant supply negative.
15	Configurable input 1	0.5mm <sup>2</sup> (20 AWG)	Requires a contact to plant supply negative.
16	Configurable input 2	0.5mm <sup>2</sup> (20 AWG)	Requires a contact to plant supply negative.
17	Functional Earth	2.5mm <sup>2</sup> (13 AWG)	Connect to a good, clean Earth point
18	Generator Current L1 i/p	2.5mm <sup>2</sup> (18 AWG)	Connect to Gen L1 CT
19	Generator Current L2 i/p	2.5mm <sup>2</sup> (18 AWG)	Connect to Gen L2 CT
20	Generator Current L3 i/p	2.5mm <sup>2</sup> (18 AWG)	Connect to Gen L3 CT
21	Generator Current Common i/p	2.5mm <sup>2</sup> (18 AWG)	Connect to Gen CT common

**NOTE:-** Current inputs are rated at 5A maximum. If it is required to measure overload, then the CT should be sized to cater for this. I.e for 100A set, fit 120A:5A CTs to allow the module to measure 20% overload without exceeding the module's 5A specification.

### 6.1.3 CONNECTOR C

PIN No	DESCRIPTION	CABLE SIZE	NOTES
22	Generator voltage L1 i/p	1.0mm <sup>2</sup> (18 AWG)	Connect to Generator L1
23	Generator voltage L2 i/p	1.0mm <sup>2</sup> (18 AWG)	Connect to Generator L2
24	Generator voltage L3 i/p	1.0mm <sup>2</sup> (18 AWG)	Connect to Generator L3
25	Generator voltage Neutral i/p	1.0mm <sup>2</sup> (18 AWG)	Connect to Generator Neutral

## 6.2 ORDERING REPLACEMENT CONNECTORS FROM DSE

Connector	Description	DSE Part No.
A (1-13)	BL13 PCB connector 5.08mm plug	007-104
B (14-21)	BL08 PCB connector 5.08mm plug	007-125
C (22-25)	BL04 PCB connector 7.62mm plug	007-171

## 7 SPECIFICATION

DC Supply	8.0V to 35V Continuous.
Cranking Dropouts	Able to survive 0V for 50mS, providing supply was at least 10V before dropout and supply recovers to 5V. <i>This is achieved without the need for internal batteries.</i>
Typical Standby Current	145mA at 12V. 150mA at 24V
Max. Operating Current	180mA at 12V. 190mA at 24V
Alternator Input Range Single phase 2 wire system 3Phase 4Wire System	35V AC - 277V AC (ph-N) (+20%) 35V AC - 277V AC (ph-N) 3 Phase 4wire (+20%) (Must be at least 15V during engine cranking)
Alternator Input Frequency	50Hz - 60 Hz at rated engine speed
Start Output	2.4 Amp DC at supply voltage.
Fuel Output	2.4 Amp DC at supply voltage.
Auxiliary Outputs	1.2 Amp DC at supply voltage.
Dimensions	209mm x 146mm (8.23" x 5.75")
Panel cut-out	182mm x 137mm (7.17" x 5.39") Maximum panel thickness – 8mm (0.3")
Charge Fail / Excitation Range	12 Volts nominal = 8 Volts Charge fail 24 Volts nominal = 16 Volts Charge fail
Current Transformer Specification	5A 0.5VA secondary winding
Operating Temperature Range	-30°C to +70°C
Electromagnetic Compatibility	BS EN 50081-2 EMC Generic Emission Standard (Industrial) BS EN 50082-2 EMC Generic Immunity Standard (Industrial)
Electrical Safety	BS EN 60950 Safety of I.T. equipment, including electrical business equipment.
Cold Temperature	BS EN 60068-2-1 to -30°C
Hot Temperature	BS EN 60068-2-2 to +70°C
Humidity	BS2011-2-1 to 93% RH @ 40°C for 48 Hours
Vibration	BS EN60068-2-6 10 sweeps at 1 octave/minute in each of 3 major axes. 5Hz to 8Hz @ +/-7.5mm constant displacement 8Hz to 500Hz @ 2gn constant acceleration
Shock	BS EN 60068-2-27 3 Half sine shocks in each of 3 major axes 15gn amplitude, 11mS duration
Applicable Standards	Compliant with BS EN 60950 Low Voltage Directive Compliant with BS EN 50081-2: 1992 EMC Directive Compliant with BS EN 61000-6-4: 2000 EMC Directive <b>CE</b> Compliance to European Legislation

## 8 COMMISSIONING

### 8.1 PRE-COMMISSIONING

Before the system is started, it is recommended that the following checks are made:-

The unit is adequately cooled and all the wiring to the module is of a standard and rating compatible with the system.

The unit DC supply is fused and connected to the battery and that it is of the correct polarity.

To check the start cycle operation take appropriate measures to prevent the engine from starting (disable the operation of the fuel solenoid). After a visual inspection to ensure it is safe to proceed, connect the battery supply. Select "MANUAL" and press "START", the unit start sequence will commence.

The starter will engage and operate for the pre-set crank period. After the starter motor has attempted to start the engine for the pre-set number of attempts the LCD will display '*Failed to start*'.

Restore the engine to operational status (reconnect the fuel solenoid), again select "MANUAL" and press "START", this time the engine should start and the starter motor should disengage automatically. If not then check that the engine is fully operational (fuel available, etc.) and that the fuel solenoid is operating. The engine should now run up to operating speed. If not, and an alarm is present, check the alarm condition for validity, then check input wiring. The engine should continue to run for an indefinite period.

Select "AUTO" on the front panel, the engine will run for the pre-set cooling down period, then stop. The generator should stay in the standby mode. If not check that there is not a signal present on the Remote start input.

Initiate an automatic start by supplying the remote start signal. The start sequence will commence and the engine will run up to operational speed. Once the generator is available a load transfer will take place, the Generator will accept the load. If not, check the wiring to the Generator switching device.

Remove the remote start signal, the return sequence will start. After the pre-set time period, the load will be removed from the generator. The generator will then run for the pre-set cooling down period, then shutdown into it's standby mode.

If despite repeated checking of the connections between the 720 and the customer's system, satisfactory operation cannot be achieved, then the customer is requested to contact the factory for further advice on:-

INTERNATIONAL TEL: +44 (0) 1723 890099

INTERNATIONAL FAX: +44 (0) 1723 893303

E-mail: [Support@Deepseapl.com](mailto:Support@Deepseapl.com)

Website : [www.deepseapl.com](http://www.deepseapl.com)

## 9 FAULT FINDING

SYMPTOM	POSSIBLE REMEDY
Unit is inoperative	Check the battery and wiring to the unit. Check the DC supply. Check the DC fuse.
Unit shuts down	Check DC supply voltage is not above 35 Volts or below 9 Volts Check the operating temperature is not above 70 °C. Check the DC fuse.
Low oil Pressure fault operates after engine has fired	Check engine oil pressure. Check oil pressure switch and wiring. Check switch polarity is correct (i.e. Normally Open or Normally Closed).
High engine temperature fault operates after engine has fired.	Check engine temperature. Check switch and wiring. Check switch polarity is correct (i.e. Normally Open or Normally Closed).
Shutdown fault operates	Check relevant switch and wiring of fault indicated by the illuminated LED. Check configuration of input.
Warning fault operates	Check relevant switch and wiring of fault indicated by the illuminated LED. Check configuration of input.
Fail to Start is activated after pre-set number of attempts to start	Check wiring of fuel solenoid. Check fuel. Check battery supply. Check battery supply is present on the Fuel output of the module. Refer to engine manual.
Continuous starting of generator when in <b>AUTO</b>	Check that there is no signal present on the "Remote Start" input.
Generator fails to start on receipt of Remote Start signal..	If remote start fault, check signal is on "Remote Start" input. Confirm that the input is configured to be used as "Remote Start".
Pre-heat inoperative	Check wiring to engine heater plugs. Check battery supply. Check battery supply is present on the Pre-heat output of module. Check pre-heat has been selected in your configuration.
Starter motor inoperative	Check wiring to starter solenoid. Check battery supply. Check battery supply is present on the Starter output of module. NB all the outputs are negative switching.
Fuel solenoid inoperative	Check wiring to fuel solenoid. Check battery supply. Check battery supply is present on the fuel output of module. NB all the outputs are negative switching.
Engine runs but generator will not take load	Check that the output is working, NB all outputs are negative switching.

**▲NOTE:- The above fault finding is provided as a guide check-list only. As it is possible for the module to be configured to provide a wide range of different features always refer to the source of your module configuration if in doubt.**

**▲NOTE:- All the outputs are solid state and switch to battery positive when active.**

# 10 TYPICAL WIRING DIAGRAM

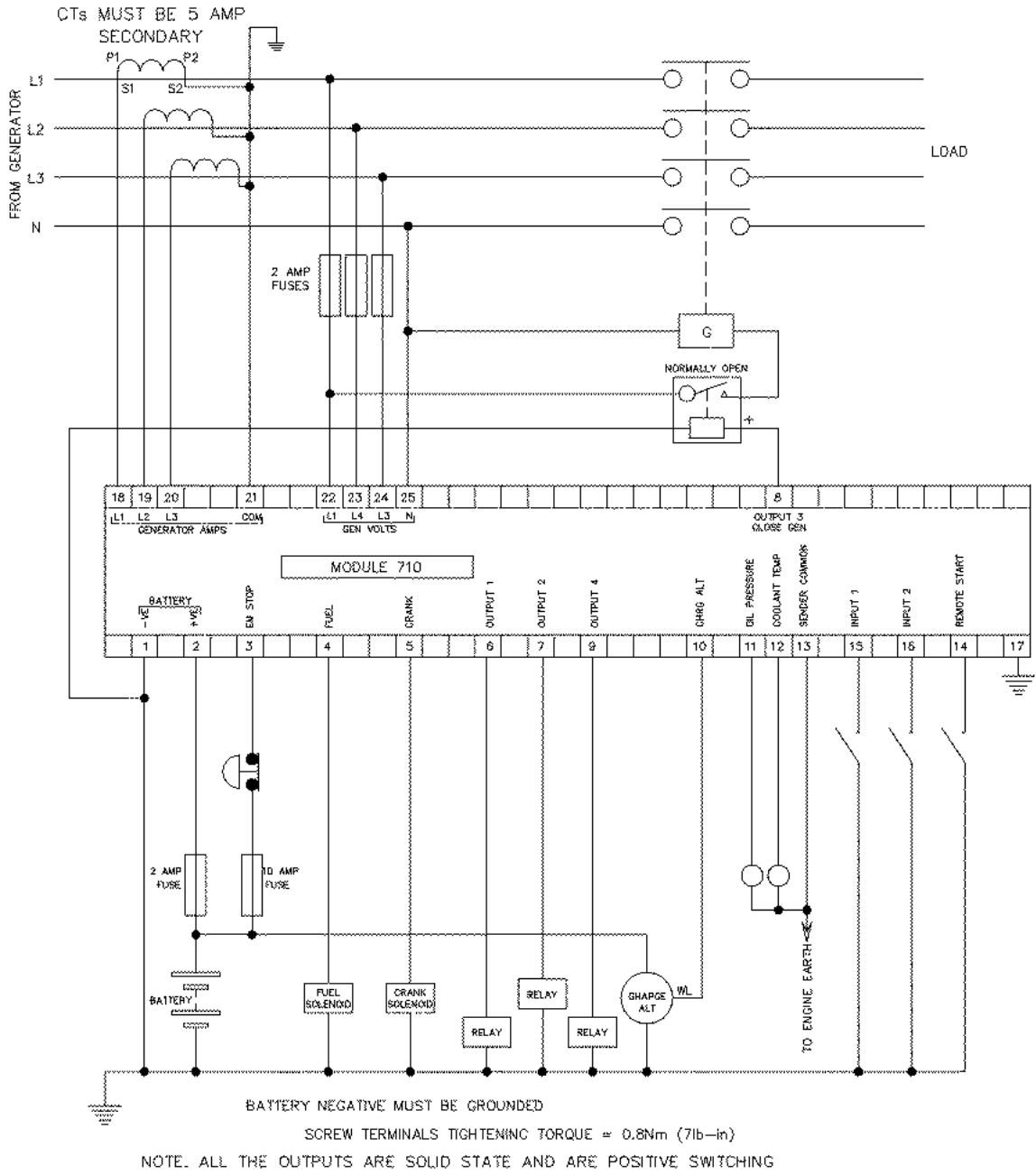



## 11 SOLID STATE OUTPUTS

DSE's utilisation of Solid State Outputs gives many advantages, the main points being:  
 No Moving Parts  
 Fully Overload / Short Circuit Protected.  
 Smaller dimensions hence lighter, thinner and cheaper than conventional relays.  
 Less power required making them far more reliable.

This type of output is normally used with an automotive or plug in relay.

Solid state output from DSE module

eg. Terminal 4 of 710 - FUEL

\* Observe polarity when using relays fitted with integral diodes!

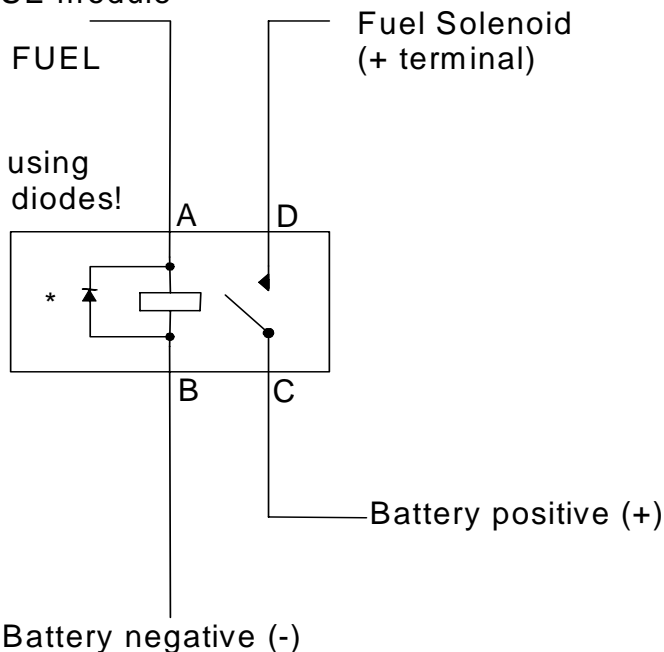

	Solid State Output from DSE Module Pin	Automotive relay Pin	8 Pin Plugin relay	Function
A	4	86	7	Fuel Output
B		85	2	To Negative supply
C		30	1	To Positive supply via fuse
D		87	3	To Fuel Solenoid

Example of relay pins connected to DSE solid state output to drive a fuel solenoid.

<<< THIS PAGE INTENTIONALLY BLANK >>>