

**COMPLEX
SOLUTIONS
MADE
SIMPLE.**



DSEULTRA[®]

DSE3110 Series Control Module

057-086

Author : Anthony Manton



Deep Sea Electronics Plc
Highfield House
Hunmanby
North Yorkshire
YO14 0PH
ENGLAND

Sales Tel: +44 (0) 1723 890099
Sales Fax: +44 (0) 1723 893303

E-mail: sales@deepseapl.com
Website: www.deepseapl.com

DSE Model 3000 series Control and Instrumentation System Operators Manual

© Deep Sea Electronics Plc

All rights reserved. No part of this publication may be reproduced in any material form (including photocopying or storing in any medium by electronic means or other) without the written permission of the copyright holder except in accordance with the provisions of the Copyright, Designs and Patents Act 1988.

Applications for the copyright holder's written permission to reproduce any part of this publication should be addressed to Deep Sea Electronics Plc at the address above.

The DSE logo and the names DSEUltra, DSEControl, DSEPower, DSEExtra, DSEMarine and DSENet are UK registered trademarks of Deep Sea Electronics PLC.

Any reference to trademarked product names used within this publication is owned by their respective companies.

Deep Sea Electronics Plc reserves the right to change the contents of this document without prior notice.

Amendments since last publication

Amd. No.	Comments
Issue 2	Update to Typical wiring diagram and Power supply requirements
Issue 2.1	Corrected part numbers for ordering spare connectors.
Issue 2.2	Removal of incorrect inclusion of Clock/Scheduler function – not available in 3000 series.
Issue 3	Addition of phase to phase voltage, AC systems and oil pressure as PSI
Issue 5	Changes to input wetting current and current consumption of supply.

Clarification of notation used within this publication.



NOTE:

Highlights an essential element of a procedure to ensure correctness.



CAUTION!

Indicates a procedure or practice, which, if not strictly observed, could result in damage or destruction of equipment.



WARNING!

Indicates a procedure or practice, which could result in injury to personnel or loss of life if not followed correctly.

TABLE OF CONTENTS

Section	Page
1 BIBLIOGRAPHY	5
2 INTRODUCTION	5
3 SPECIFICATIONS	6
3.1 POWER SUPPLY REQUIREMENTS	6
3.2 TERMINAL SPECIFICATION.....	6
3.3 GENERATOR VOLTAGE / FREQUENCY SENSING.....	6
3.4 INPUTS.....	7
3.4.1 DIGITAL INPUTS	7
3.4.2 CHARGE FAIL INPUT	7
3.4.3 MAGNETIC PICKUP	7
3.5 OUTPUTS.....	7
3.5.1 OUTPUTS A & B (FUEL AND START).....	7
3.5.2 CONFIGURABLE OUTPUTS C & D	7
3.6 COMMUNICATION PORTS	8
3.7 ACCUMULATED INSTRUMENTATION.....	8
3.8 DIMENSIONS AND MOUNTING	9
3.8.1 DIMENSIONS.....	9
3.8.2 PANEL CUTOUT	9
3.8.3 WEIGHT.....	9
3.8.4 FIXING CLIPS	9
3.8.5 OPTIONAL SILICON SEALING GASKET.....	9
3.9 APPLICABLE STANDARDS.....	10
4 INSTALLATION	11
4.1 USER CONNECTIONS	11
4.2 TERMINAL DESCRIPTION.....	12
4.2.1 DC SUPPLY, FUEL AND START OUTPUTS.....	12
4.2.2 GENERATOR VOLTAGE SENSING AND DIGITAL INPUTS.....	12
4.2.3 MAGNETIC PICKUP AND DIGITAL INPUTS (MODEL 3110-XX-01)	12
4.2.4 CAN AND DIGITAL INPUTS (MODEL 3110-XX-02).....	13
4.2.5 PC CONFIGURATION INTERFACE CONNECTOR	13
4.3 TYPICAL WIRING DIAGRAM	14
5 DESCRIPTION OF CONTROLS	15
5.1 QUICKSTART GUIDE.....	16
5.1.1 STARTING THE ENGINE.....	16
5.1.2 STOPPING THE ENGINE	16
5.2 GRAPHICAL DISPLAY	17
5.3 VIEWING THE INSTRUMENTS	17
5.4 CONTROLS.....	18
6 OPERATION	19
6.1 AUTOMATIC MODE OF OPERATION.....	19
6.1.1 WAITING IN AUTO MODE	19
6.1.2 STARTING SEQUENCE.....	19
6.1.3 ENGINE RUNNING	20
6.1.4 STOPPING SEQUENCE	20
6.2 MANUAL OPERATION	21
6.2.1 WAITING IN MANUAL MODE	21

6.2.2	STARTING SEQUENCE	21
6.2.3	ENGINE RUNNING	22
6.2.4	STOPPING SEQUENCE	22
7	PROTECTIONS	23
7.1	WARNINGS	23
7.2	SHUTDOWNS.....	23
8	MODULE DISPLAY.....	24
8.1	TIMER ICON.....	24
8.2	STOPPED ICON.....	24
8.3	RUNNING ICON.....	24
8.4	USB ICON.....	24
8.5	MEMORY CORRUPTION	24
8.6	BACKLIGHT	24
8.7	FAULT ICONS.....	25
9	FRONT PANEL CONFIGURATION.....	26
9.1	ACCESSING THE FRONT PANEL EDITOR (FPE)	26
9.1.1	EDITING A PARAMETER	27
9.1.2	ADJUSTABLE PARAMETERS	28
10	COMMISSIONING.....	33
10.1.1	PRE-COMMISSIONING	33
11	FAULT FINDING	34
12	MAINTENANCE, SPARES, REPAIR AND SERVICING	36
12.1	PURCHASING ADDITIONAL CONNECTOR PLUGS FROM DSE	36
12.2	PURCHASING ADDITIONAL FIXING CLIPS FROM DSE.....	36
12.3	PURCHASING SEALING GASKET FROM DSE	36
13	WARRANTY.....	37
14	DISPOSAL	37
14.1	WEEE (WASTE ELECTRICAL AND ELECTRONIC EQUIPMENT)ERROR! BOOKMARK NOT DEFINED.	
14.2	ROHS (RESTRICTION OF HAZARDOUS SUBSTANCES)ERROR! BOOKMARK NOT DEFINED.	
15	APPENDIX	38
15.1	CAN INTERFACE.....	38
15.2	COMMUNICATIONS OPTION CONNECTIONS.....	39
15.2.1	DESCRIPTION.....	39
15.2.2	PC TO CONTROLLER (DIRECT) CONNECTION	39
15.3	ENCLOSURE CLASSIFICATIONS.....	40

1 BIBLIOGRAPHY

This document refers to and is referred to by the following DSE publications which can be obtained from the DSE website www.deepseapl.com

DSE PART	DESCRIPTION
053-050	3110 installation instructions
057-004	Electronic Engines and DSE wiring manual
057-087	3000 Series Configuration Suite manual

2 INTRODUCTION

This document details the installation and operation requirements of the DSE3000 Series modules, part of the DSEUltra® range of products.

The manual forms part of the product and should be kept for the entire life of the product. If the product is passed or supplied to another party, ensure that this document is passed to them for reference purposes.

This is not a *controlled document*. You will not be automatically informed of updates. Any future updates of this document will be included on the DSE website at www.deepseapl.com

The **DSE 3000 series** module has been designed to allow the operator to start and stop the engine/generator, and if required, transfer the load.

The user also has the facility to view the system operating parameters via the LCD display.

The **DSE 3000** module monitors the engine, indicating the operational status and fault conditions, automatically shutting down the engine and giving a true first up fault condition of an engine failure. The LCD display indicates the fault.

The powerful microprocessor contained within the module allows for incorporation of a range of enhanced features:

- *Text based LCD display*
- **True RMS** Voltage monitoring.
- *Engine parameter monitoring.*
- *Fully configurable inputs for use as alarms or a range of different functions.*
- *Engine ECU interface to **electronic engines** (specify on ordering)*
- *Magnetic pickup interface for engine only applications (specify on ordering)*

Using a PC and the 3000 series configuration software allows alteration of selected operational sequences, timers and alarm trips.

Additionally, the module's integral fascia configuration editor allows adjustment of this information.

A robust plastic case designed for front panel mounting houses the module. Connections are via locking plug and sockets.

3 SPECIFICATIONS

3.1 POWER SUPPLY REQUIREMENTS

Minimum supply voltage	8V continuous
Cranking dropouts	Able to survive 0V for 50mS providing the supply was at least 10V before the dropout and recovers to 5V afterwards.
Maximum supply voltage	35V continuous (60V protection)
Reverse polarity protection	-35V continuous
Maximum operating current 3110-001-xx to 3110-005-xx	30mA at 24V 35mA at 12V
Maximum operating current 3110-006-xx onwards	76mA at 24V 61mA at 12V
Nominal standby current 3110-001-xx to 3110-005-xx	23mA at 24V 18mA at 12V
Nominal standby current 3110-006-xx onwards	45mA at 24V 43mA at 12V
Maximum <i>Power Save</i> mode current*	3.5mA at 24V 3.5mA at 12V

 **NOTE:-** * *Power Save* mode is a configurable item. If enabled, the module switches to *Power Save* mode when in STOP mode for more than 1 minute (60 seconds)

Plant supply instrumentation display

Range	0V-60V DC (note Maximum continuous operating voltage of 35V DC)
Resolution	0.1V
Accuracy	1% full scale

3.2 TERMINAL SPECIFICATION

Connection type	Screw terminal, rising clamp, no internal spring
Min cable size	0.5mm ² (AWG 24)
Max cable size	2.5mm ² (AWG 10)

3.3 GENERATOR VOLTAGE / FREQUENCY SENSING

Measurement type	True RMS conversion
Sample Rate	5KHz or better
Harmonics	Up to 11 th or better
Input Impedance	300K Ω ph-N
Phase to Neutral	15V to 333V AC (max)
Phase to Phase	25V to 576V AC (max)
Common mode offset from Earth	100V AC (max)
Resolution	1V AC phase to neutral 2V AC phase to phase
Accuracy	$\pm 1\%$ of full scale phase to neutral $\pm 2\%$ of full scale phase to phase
Minimum frequency	3.5Hz
Maximum frequency	75.0Hz
Frequency resolution	0.1Hz
Frequency accuracy	$\pm 0.2\text{Hz}$

3.4 INPUTS

3.4.1 DIGITAL INPUTS

Number	6
Arrangement	Contact between terminal and ground
Low level threshold	40% of DC supply voltage
High level threshold	60% of DC supply voltage
Maximum input voltage	DC supply voltage positive terminal
Minimum input voltage	DC supply voltage negative terminal
Contact wetting current 3110-001-xx to 3110-005-xx	2.5mA @12V typical 5mA @ 24V typical
Contact wetting current 3110-006-xx onwards	2.7mA @12V typical 5.5mA @ 24V typical
Open circuit voltage	Plant supply

3.4.2 CHARGE FAIL INPUT

Minimum voltage	0V
Maximum voltage	35V (plant supply)
Resolution	0.2V
Accuracy	± 1% of max measured voltage
Excitation	Active circuit constant power output
Output Power	2.5W Nominal @12V and 24V
Current at 12V	210mA
Current at 24V	105mA

3.4.3 MAGNETIC PICKUP

Type	Single ended input, capacitive coupled
Minimum voltage	0.5V RMS
Max common mode voltage	±2V
Maximum voltage	Clamped to ±70V by transient suppressers, dissipation not to exceed 1W.
Maximum frequency	10,000Hz
Resolution	6.25 RPM
Accuracy	±25 RPM
Flywheel teeth	10 to 500

3.5 OUTPUTS

3.5.1 OUTPUTS A & B (FUEL AND START)

Type	Fuel (A) and Start (B) outputs. Supplied from DC supply terminal 2. Fully configurable when CAN engine is selected.
Rating	2A @ 35V
Protection	Protected against over current & over temperature. Built in load dump feature.

3.5.2 CONFIGURABLE OUTPUTS C & D

Type	Fully configurable, supplied from DC supply terminal 2.
Rating	2A @ 35V
Protection	Protected against over current & over temperature. Built in load dump feature.

3.6 COMMUNICATION PORTS

USB Port	USB2.0 Device for connection to PC running DSE configuration suite only
CAN Port	Engine CAN Port Standard implementation of 'Slow mode', up to 250K bits/s Non Isolated. Internal Termination provided (120Ω)

3.7 ACCUMULATED INSTRUMENTATION

▲ NOTE : When an accumulated instrumentation value exceeds the maximum number as listed below, it will reset and begin counting from zero again.

Engine hours run	Maximum 99999 hrs 59 minutes (approximately 11yrs 4months)
Number of starts	1,000,000 (1 million)

3.8 DIMENSIONS AND MOUNTING

3.8.1 DIMENSIONS

99mm x 79 mm x 40mm (3.9" x 3.1" x 1.6")

3.8.2 PANEL CUTOUT

80mm x 68mm (3.2" x 2.7")

3.8.3 WEIGHT

89g (0.089kg)

3.8.4 FIXING CLIPS

The module is held into the panel fascia using the supplied fixing clips.

- Withdraw the fixing clip screw (turn anticlockwise) until only the pointed end is protruding from the clip.
- Insert the three 'prongs' of the fixing clip into the slots in the side of the 3000 series module case.
- Pull the fixing clip backwards (towards the back of the module) ensuring all three prongs of the clip are inside their allotted slots.
- Turn the fixing clip screws clockwise until they make contact with the panel fascia.
- Turn the screws a little more to secure the module into the panel fascia. Care should be taken not to over tighten the fixing clip screws.

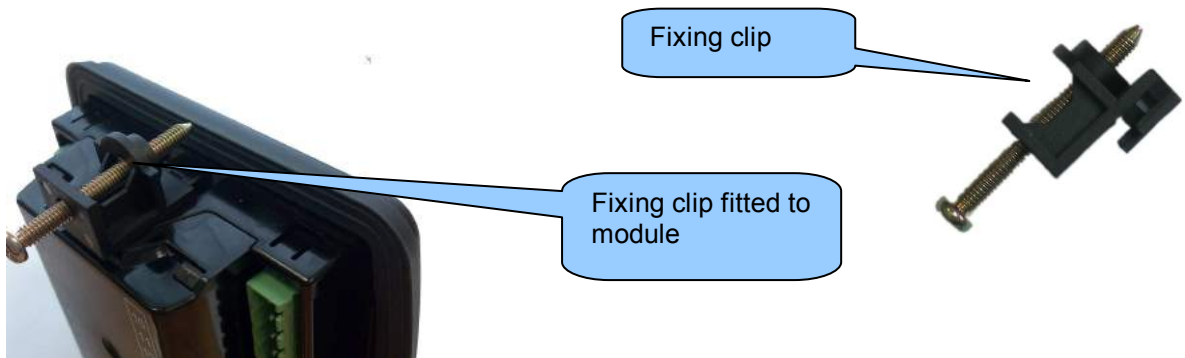

NOTE:- In conditions of excessive vibration, mount the panel on suitable anti-vibration mountings.

3.8.5 OPTIONAL SILICON SEALING GASKET

The optional silicon gasket provides improved sealing between the 3000 series module and the panel fascia. The gasket is fitted to the module before installation into the panel fascia.

Take care to ensure the gasket is correctly fitted to the module to maintain the integrity of the seal.

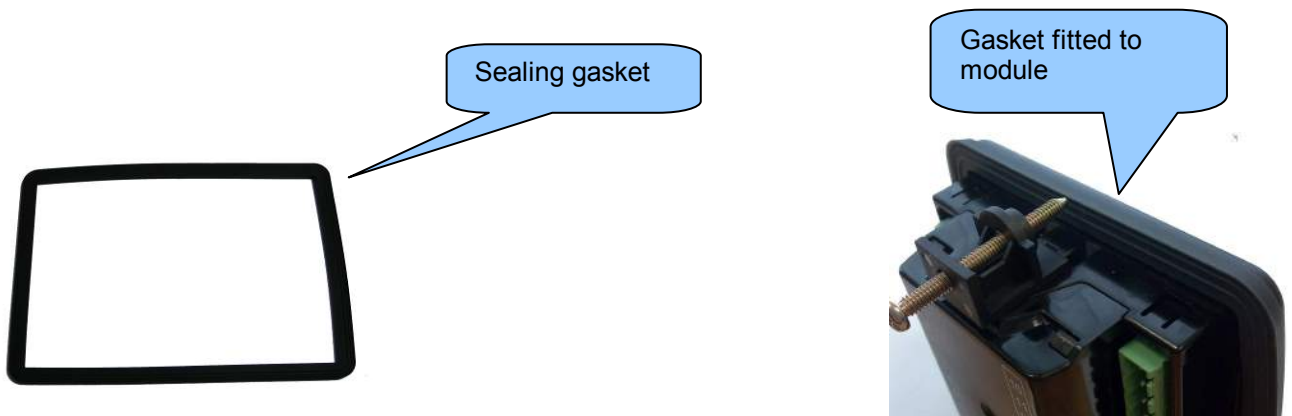

3.9 APPLICABLE STANDARDS

BS 4884-1	This document conforms to BS4884-1 1992 Specification for presentation of essential information.
BS 4884-2	This document conforms to BS4884-2 1993 Guide to content
BS 4884-3	This document conforms to BS4884-3 1993 Guide to presentation
BS EN 60068-2-1 (Minimum temperature)	-30°C (-22°F)
BS EN 60068-2-2 (Maximum temperature)	+70°C (158°F)
BS EN 60950	Safety of information technology equipment, including electrical business equipment
BS EN 61000-6-2	EMC Generic Immunity Standard (Industrial)
BS EN 61000-6-4	EMC Generic Emission Standard (Industrial)
BS EN 60529 (Degrees of protection provided by enclosures)	IP65 (front of module when installed into the control panel with the optional sealing gasket) IP42 (front of module when installed into the control panel WITHOUT being sealed to the panel)
UL508 NEMA rating (Approximate)	12 (Front of module when installed into the control panel with the optional sealing gasket). 2 (Front of module when installed into the control panel WITHOUT being sealed to the panel)
IEEE C37.2 (Standard Electrical Power System Device Function Numbers and Contact Designations)	<p>Under the scope of IEEE 37.2, <i>function numbers can also be used to represent functions in microprocessor devices and software programs.</i></p> <p>The 3000 series controller is device number 11L-3000 (Multifunction device protecting Line (generator) – 3000 series module).</p> <p>As the module is configurable by the generator OEM, the functions covered by the module will vary. Under the module's factory configuration, the device numbers included within the module are :</p> <ul style="list-style-type: none"> 2 – Time delay starting or closing relay 6 – Starting circuit breaker 30 – annunciator relay 42 – Running circuit breaker 54 – turning gear engaging device 62 – time delay stopping or opening relay 63 – pressure switch 74– alarm relay 81 – frequency relay 86 – lockout relay

In line with our policy of continual development, Deep Sea Electronics, reserve the right to change specification without notice.

4 INSTALLATION

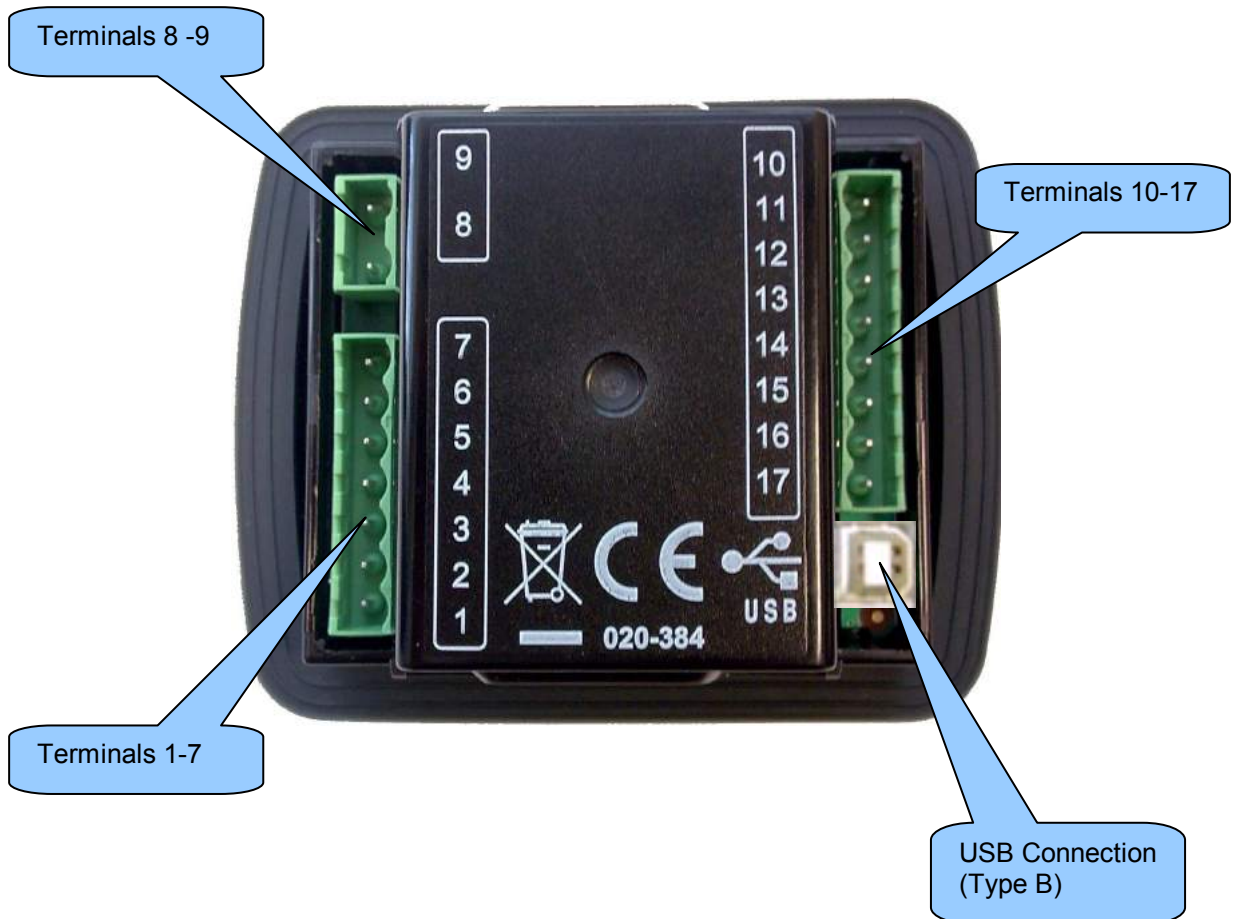

The DSE3000 Series module is designed to be mounted on the panel fascia. For dimension and mounting details, see the section entitled *Specification, Dimension and mounting* elsewhere in this document.

4.1 USER CONNECTIONS



4.2 TERMINAL DESCRIPTION

4.2.1 DC SUPPLY, FUEL AND START OUTPUTS

	PIN No	DESCRIPTION	CABLE SIZE	NOTES
	1	DC Plant Supply Input (Negative)	2.5mm ² AWG 13	
	2	DC Plant Supply Input (Positive)	2.5 mm ² AWG 13	(Recommended Maximum Fuse 15A anti-surge) Supplies the module (2A anti-surge requirement) and all output relays
	3	Output A (FUEL)	1.0mm ² AWG 18	Plant Supply Positive from terminal 2. 3 Amp rated.
	4	Output B (START)	1.0mm ² AWG 18	Plant Supply Positive from terminal 2. 3 Amp rated.
	5	Output C	1.0mm ² AWG 18	Plant Supply Positive from terminal 2. 3 Amp rated.
	6	Output D	1.0mm ² AWG 18	Plant Supply Positive from terminal 2. 3 Amp rated.
D + W/L	7	Charge fail / excite	2.5mm ² AWG 13	Do not connect to ground (battery negative). If charge alternator is not fitted, leave this terminal disconnected.



4.2.2 GENERATOR VOLTAGE SENSING AND DIGITAL INPUTS

	PIN No	DESCRIPTION	CABLE SIZE	NOTES
	8	Generator Neutral (N) input	1.0mm ² AWG 18	Connect to generator Neutral terminal (AC)
	9	Generator L1 (U) voltage monitoring	1.0mm ² AWG 18	Connect to generator L1 (U) output (AC) (Recommend 2A fuse)

4.2.3 MAGNETIC PICKUP AND DIGITAL INPUTS (MODEL 3110-XX-01)

Model 3110-xx-01 (Magnetic pickup enabled module)

NOTE:- CAN interface is not fitted to the 3110-xx-01 module



	PIN No	DESCRIPTION	CABLE SIZE	NOTES
	10	Magnetic pickup Positive	0.5mm ² AWG 20	Connect to Magnetic Pickup device
	11	Magnetic pickup Negative	0.5mm ² AWG 20	Connect to Magnetic Pickup device
	12	Configurable digital input A	0.5mm ² AWG 20	Switch to negative
	13	Configurable digital input B	0.5mm ² AWG 20	Switch to negative
	14	Configurable digital input C	0.5mm ² AWG 20	Switch to negative
	15	Configurable digital input D	0.5mm ² AWG 20	Switch to negative
	16	Configurable digital input E	0.5mm ² AWG 20	Switch to negative
	17	Configurable digital input F	0.5mm ² AWG 20	Switch to negative

NOTE:- Screened cable must be used for connecting the Magnetic Pickup, ensuring that the screen is earthed at one end ONLY.

4.2.4 CAN AND DIGITAL INPUTS (MODEL 3110-XX-02)

Model 3110-xx-020 (Can enabled module) only.



 **NOTE:- Magnetic Pickup interface is not fitted to the 3110-xx-02 module**

	PIN No	DESCRIPTION	CABLE SIZE	NOTES
	10	CAN port L	0.5mm ² AWG 20	Use only 120Ω CAN approved cable
	11	CAN port H	0.5mm ² AWG 20	Use only 120Ω CAN approved cable
	12	Configurable digital input A	0.5mm ² AWG 20	Switch to negative
	13	Configurable digital input B	0.5mm ² AWG 20	Switch to negative
	14	Configurable digital input C	0.5mm ² AWG 20	Switch to negative
	15	Configurable digital input D	0.5mm ² AWG 20	Switch to negative
	16	Configurable digital input E	0.5mm ² AWG 20	Switch to negative
	17	Configurable digital input F	0.5mm ² AWG 20	Switch to negative

 **NOTE:- Screened 120Ω impedance cable specified for use with CAN must be used for the CAN link and the Multiset comms link.**
DSE stock and supply Belden cable 9841 which is a high quality 120Ω impedance cable suitable for CAN use (DSE part number 016-030)

4.2.5 PC CONFIGURATION INTERFACE CONNECTOR

This configuration cable is the same as normally used between a PC and a USB printer.

	DESCRIPTION	CABLE SIZE	NOTES
	Socket for connection to PC with DSE Configuration Suite PC software.	0.5mm ² AWG 20	This is a standard USB type A to type B cable. 

 **NOTE:- The USB connection cable between the PC and the 3000 series module must not be extended beyond 5m (5yds). For distances over 5m, it is possible to use a third party USB extender. Typically, they extend USB up to 50m (yds). The supply and support of this type of equipment is outside the scope of Deep Sea Electronics PLC.**

 **CAUTION!: Care must be taken not to overload the PCs USB system by connecting more than the recommended number of USB devices to the PC. For further information, consult your PC supplier.**

 **CAUTION!: This socket must not be used for any other purpose.**

4.3 TYPICAL WIRING DIAGRAM

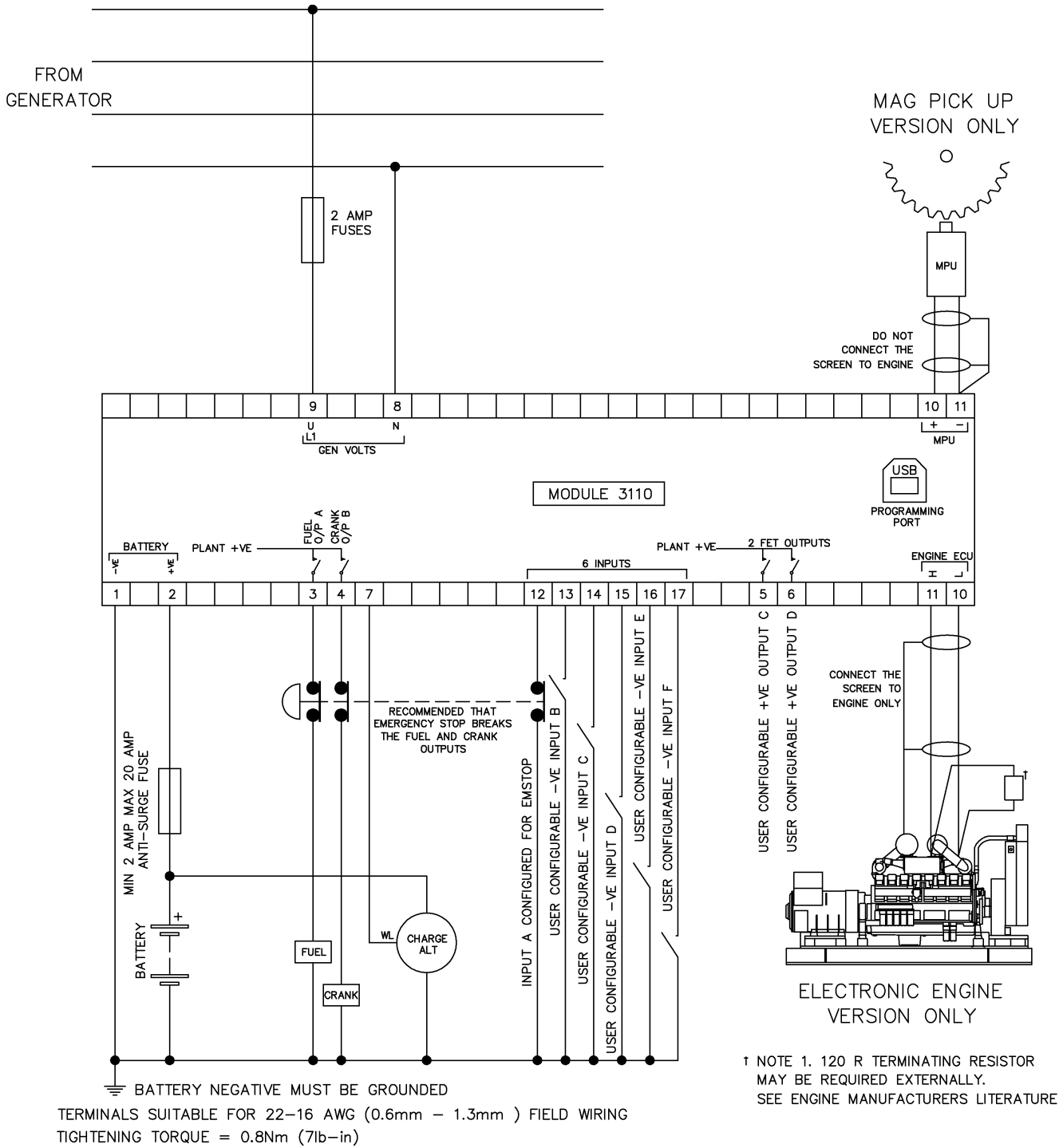

5 DESCRIPTION OF CONTROLS

The following section details the function and meaning of the various controls on the module.

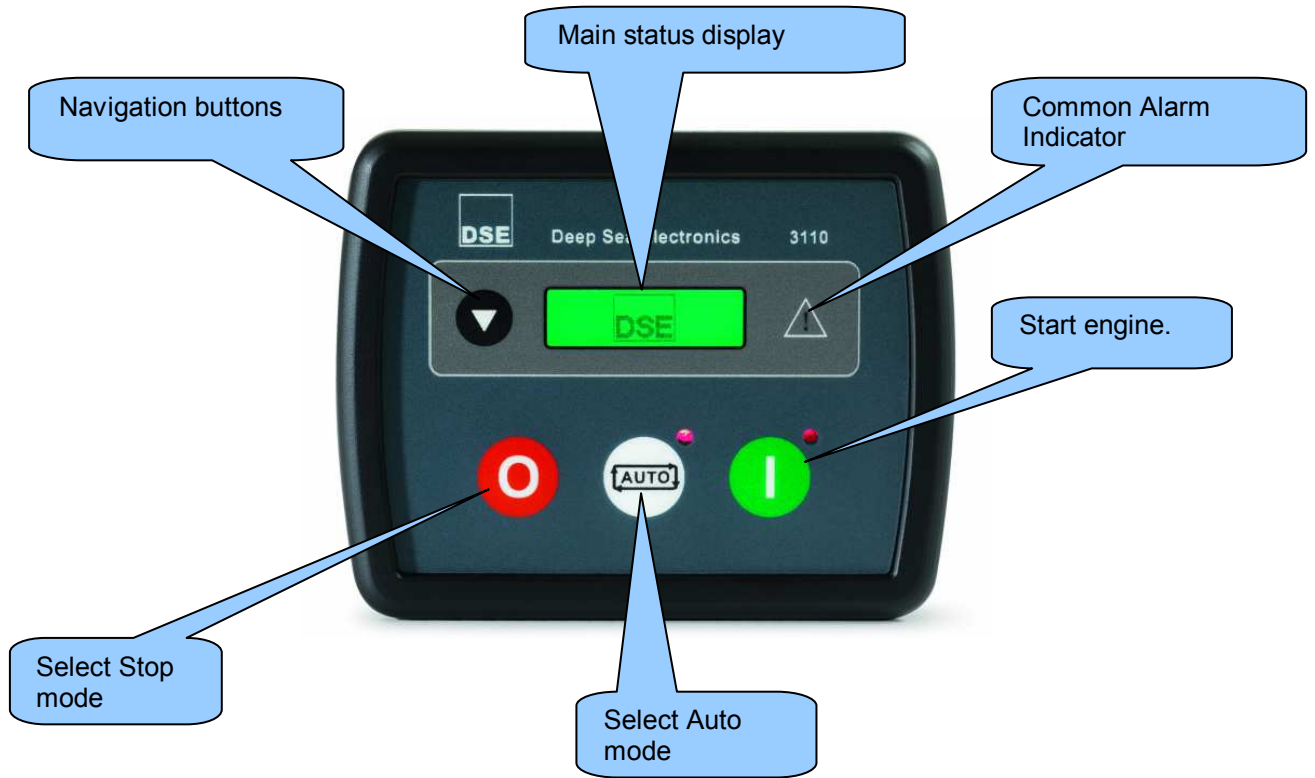

5.1 QUICKSTART GUIDE

This section provides a quick start guide to the module's operation.

5.1.1 STARTING THE ENGINE

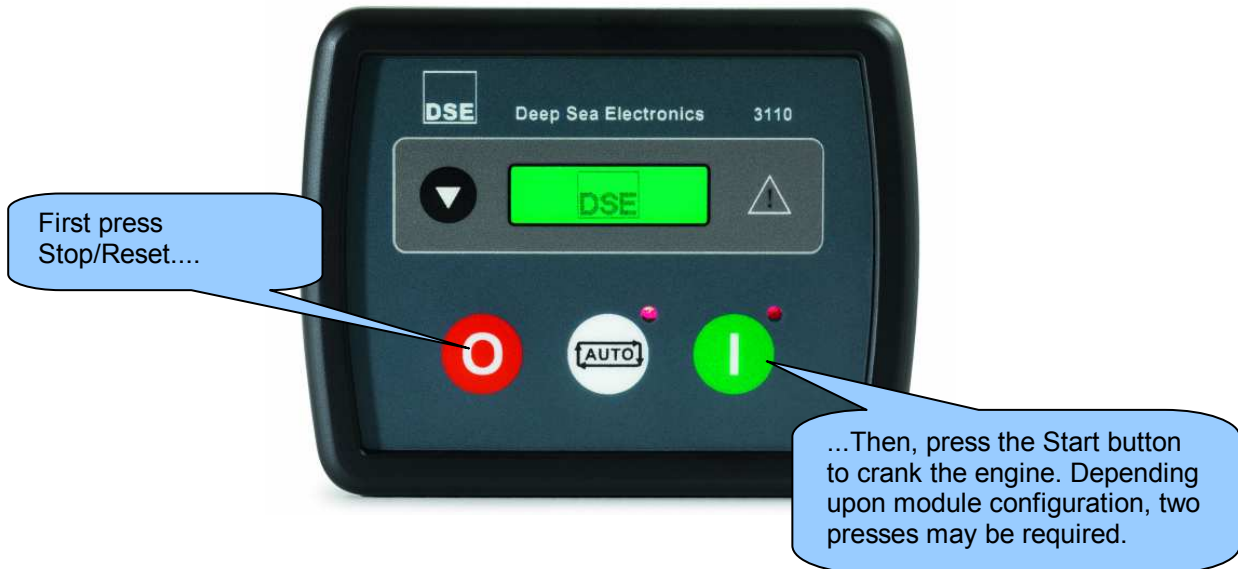

NOTE:- For further details, see the section entitled 'OPERATION' elsewhere in this manual.

5.1.2 STOPPING THE ENGINE



NOTE:- For further details, see the section entitled 'OPERATION' elsewhere in this manual.

5.2 GRAPHICAL DISPLAY

A 32x132 pixel LCD (35mm / 1.4") is available for the display of generator instrumentation and alarm conditions. The display is segmented into areas for instrumentation, unit, alarm icons and for Front Panel Editor (FPE) use.



When not in the Front Panel Editor (FPE) mode the FPE area of the display is used to display the currently active configuration. The letter 'M' is displayed for main configuration active, the letter 'A' for alternative configuration active.

5.3 VIEWING THE INSTRUMENTS

It is possible to scroll to display the different pages of information by repeatedly operating the scroll button .

Once selected the page will remain on the LCD display until the user selects a different page or after an extended period of inactivity, the module will revert to the status display.



When scrolling manually, the display will automatically return to the Status page if no buttons are pressed for the duration of the configurable *LCD Page Timer*.

If an alarm becomes active while viewing the status page, the display shows the Alarms page to draw the operator's attention to the alarm condition.

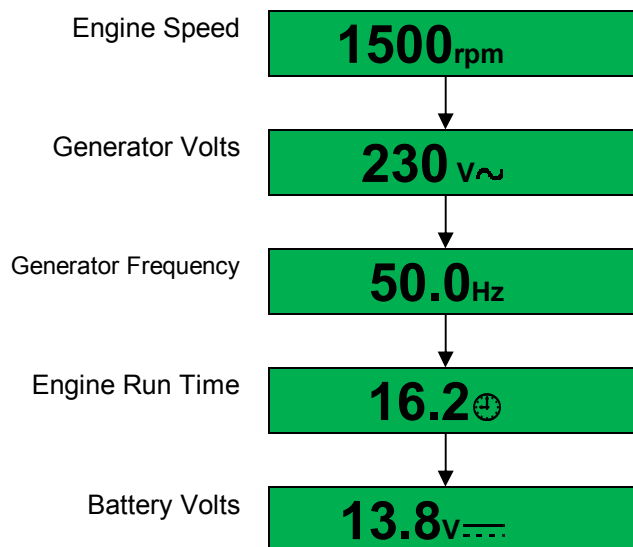
Page order:-



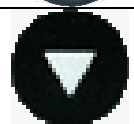

5.4 CONTROLS

<p>Stop / Reset</p>	
<p>This button places the module into its Stop/Reset mode. This will clear any alarm conditions for which the triggering criteria have been removed. If the engine is running and the module is in Stop mode, the module will automatically instruct the changeover device to unload the generator ('Close Generator' becomes inactive (if used)). The fuel supply de-energises and the engine comes to a standstill. Should a remote start signal be present while operating in this mode, a remote start will <u>not</u> occur.</p>	
<p>Auto</p>	
<p>This button places the module into its 'Automatic' mode. This mode allows the module to control the function of the generator automatically. The module will monitor the <i>remote start</i> input and once a start request is made, the set will be automatically started and placed on load. Upon removal of the starting signal, the module will automatically transfer the load from the generator and shut the set down observing the <i>stop delay</i> timer and <i>cooling</i> timer as necessary. The module will then await the next start event. <i>For further details, please see the more detailed description of 'Auto operation' elsewhere in this manual.</i></p>	
<p>Start</p>	
<p>Pressing this button in auto mode will start the engine and run off load. Pressing this button in STOP/RESET mode will turn on the CAN engine ECU (when correctly configured and fitted to a compatible engine ECU)</p>	
<p>Page</p>	
<p>Pressing this button scrolls the display to show the various instruments.</p>	

6 OPERATION

6.1 AUTOMATIC MODE OF OPERATION

NOTE:- If a digital input configured to *panel lock* is active, changing module modes will not be possible. Viewing the instruments and event logs is **NOT** affected by panel lock.

Activate auto mode by pressing the  pushbutton. The  icon is displayed to indicate Auto Mode operation if no alarms are present.

Auto mode will allow the generator to operate fully automatically, starting and stopping as required with no user intervention.

6.1.1 WAITING IN AUTO MODE

If a starting request is made, the starting sequence will begin. Starting requests can be from the following sources :

- Activation of an auxiliary input that has been configured to *remote start*

6.1.2 STARTING SEQUENCE

To allow for 'false' start requests, the *start delay* timer begins.

Should all start requests be removed during the *start delay* timer, the unit will return to a stand-by state.

If a start request is still present at the end of the *start delay* timer, the fuel relay is energised and the engine will be cranked.

NOTE:- If the unit has been configured for CAN, compatible ECU's will receive the start command via CAN.

If the engine fails to fire during this cranking attempt then the starter motor is disengaged for the *crank rest* duration after which the next start attempt is made. Should this sequence continue beyond the set number of attempts, the start sequence will be terminated and the display shows  **Fail to Start**.

When the engine fires, the starter motor is disengaged. Speed detection is factory configured to be derived from the main alternator output frequency but can additionally be measured from a Magnetic Pickup mounted on the flywheel (Selected by PC using the 3000 series configuration software).

Additionally, rising oil pressure can be used to disconnect the starter motor (but cannot detect underspeed or overspeed).

NOTE:- If the unit has been configured for CAN, speed sensing is via CAN.

After the starter motor has disengaged, the *Safety On* timer activates, allowing Oil Pressure, High Engine Temperature, Under-speed, Charge Fail and any delayed Auxiliary fault inputs to stabilise without triggering the fault.

6.1.3 ENGINE RUNNING

Once the engine is running and all starting timers have expired, the animated  icon is displayed.

DSE3110 - The generator will be placed on load if configured to do so.

▲ NOTE:-The load transfer signal remains inactive until the Oil Pressure has risen. This prevents excessive wear on the engine.

If all start requests are removed, the *stopping sequence* will begin.

6.1.4 STOPPING SEQUENCE

The *return delay* timer operates to ensure that the starting request has been permanently removed and isn't just a short term removal. Should another start request be made during the cooling down period, the set will return on load.

If there are no starting requests at the end of the *return delay* timer, the load is removed from the generator to the mains supply and the *cooling* timer is initiated.

The *cooling* timer allows the set to run off load and cool sufficiently before being stopped. This is particularly important where turbo chargers are fitted to the engine.

After the *cooling* timer has expired, the set is stopped.



6.2 MANUAL OPERATION

NOTE:- If a digital input configured to *panel lock* is active, changing module modes will not be possible. Viewing the instruments and event logs is NOT affected by panel lock.

Manual mode allows the operator to start and stop the set manually, and if required change the state of the load switching devices. Module mode is active when the  button is pressed.

6.2.1 WAITING IN MANUAL MODE

To begin the starting sequence, press the  button. If 'protected start' is disabled, the start sequence begins immediately.

If 'Protected Start' is enabled, the  icon is displayed to indicate Manual mode and the manual LED flashes. The  button must be pressed once more to begin the start sequence.

6.2.2 STARTING SEQUENCE

NOTE:- There is no *start delay* in this mode of operation.

The fuel relay is energised and the engine is cranked.

NOTE:- If the unit has been configured for CAN, compatible ECU's will receive the start command via CAN.

If the engine fails to fire during this cranking attempt then the starter motor is disengaged for the *crank rest* duration after which the next start attempt is made. Should this sequence continue beyond the set number of attempts, the start sequence will be terminated and the display shows  **Fail to Start**.

When the engine fires, the starter motor is disengaged. Speed detection is factory configured to be derived from the main alternator output frequency but can additionally be measured from a Magnetic Pickup mounted on the flywheel (Selected by PC using the 3000 series configuration software).

Additionally, rising oil pressure can be used disconnect the starter motor (but cannot detect underspeed or overspeed).

NOTE:- If the unit has been configured for CAN, speed sensing is via CAN.

After the starter motor has disengaged, the *Safety On* timer activates, allowing Oil Pressure, High Engine Temperature, Under-speed, Charge Fail and any delayed Auxiliary fault inputs to stabilise without triggering the fault.



6.2.3 ENGINE RUNNING

In manual mode, the load is not transferred to the generator unless a 'loading request' is made. A loading request can come from a number of sources.

- Activation of an auxiliary input that has been configured to *remote start on load*
- Activation of the inbuilt exercise scheduler if configured for 'on load' runs.



NOTE:-The load transfer signal remains inactive until the Oil Pressure has risen. This prevents excessive wear on the engine.

Once the load has been transferred to the generator, it will not be automatically removed. To manually transfer the load back to the mains either:

- Press the *auto mode*  button to return to automatic mode. The set will observe all auto mode start requests and stopping timers before beginning the *Auto mode stopping sequence*.
- Press the *stop button* 
- De-activation of an auxiliary input that has been configured to *remote start on load*

6.2.4 STOPPING SEQUENCE

In manual mode the set will continue to run until either :

- The *stop button*  is pressed – The set will immediately stop
- The *auto button*  is pressed. The set will observe all auto mode start requests and stopping timers before beginning the *Auto mode stopping sequence*.

7 PROTECTIONS

When an alarm is present, the Common alarm LED if configured will illuminate.

The LCD display will show an icon to indicate the failure.

7.1 WARNINGS

Warnings are non-critical alarm conditions and do not affect the operation of the generator system, they serve to draw the operators attention to an undesirable condition.

Warning alarms are self-resetting when the fault condition is removed. The icon will appear steady in the display.

7.2 SHUTDOWNS

Shutdowns are critical alarm conditions that stop the engine and draw the operator's attention to an undesirable condition.

Shutdown alarms are latching. The fault must be removed and the  button pressed to reset the module. The icon will appear flashing in the display.

8 MODULE DISPLAY

8.1 TIMER ICON

When the module is controlling the engine (starting and stopping) an animated timer icon will be displayed in the icon area to indicate that a timer is active, for example cranking time, crank rest etc.



8.2 STOPPED ICON

When there are no alarms present, an icon will be displayed to indicate the engine is stopped and what mode the unit is in.



Stop
mode



Auto
mode



Manual
mode

The hand is only displayed when the 'arming options' is enabled, otherwise the engine starts when entering the manual mode.

8.3 RUNNING ICON

When there are no alarms present, an animated icon is displayed to indicate the engine is running :



8.4 USB ICON

When a USB connection is made to the module the USB icon is displayed :

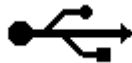

8.5 MEMORY CORRUPTION



















If either the config file or engine file becomes corrupted the unit will display the following icon :



8.6 BACKLIGHT

The backlight will be on if the unit has sufficient voltage on the power connection while the unit is turned on, unless the unit is cranking for which the backlight will be turned off.

8.7 FAULT ICONS

ICON	DESCRIPTION	
	AUXILIARY INPUTS	Auxiliary inputs can be user configured and will display the message as written by the user.
	FAIL TO START	The engine has not fired after the preset number of start attempts
	FAIL TO STOP	The module has detected a condition that indicates that the engine is running when it has been instructed to stop. ▲NOTE:- 'Fail to Stop' could indicate a faulty oil pressure sensor - If engine is at rest check oil sensor wiring and configuration.
	LOW OIL PRESSURE	The module detects that the engine oil pressure has fallen below the low oil pressure pre-alarm setting level after the <i>Safety On</i> timer has expired.
	ENGINE HIGH TEMPERATURE	The module detects that the engine coolant temperature has exceeded the high engine temperature pre-alarm setting level after the <i>Safety On</i> timer has expired.
	UNDERSPEED	The engine speed has fallen below the underspeed pre alarm setting
	OVERSPEED	The engine speed has risen above the overspeed pre alarm setting
	CHARGE FAILURE	The auxiliary charge alternator voltage is low as measured from the W/L terminal.
	LOW FUEL LEVEL	The level detected by the fuel level sensor is below the low fuel level setting.
	BATTERY UNDER VOLTAGE / BATTERY OVER VOLTAGE	The DC supply has fallen below or risen above the low/high volts setting level.
	GENERATOR UNDER VOLTAGE	The generator output voltage has fallen below the pre-set pre-alarm setting after the <i>Safety On</i> timer has expired.
	GENERATOR OVER VOLTAGE	The generator output voltage has risen above the pre-set pre-alarm setting.
	GENERATOR UNDER FREQUENCY	The generator output frequency has fallen below the pre-set pre-alarm setting after the <i>Safety On</i> timer has expired.
	GENERATOR OVER FREQUENCY	The generator output frequency has risen above the pre-set pre-alarm setting.
	CAN ECU WARNING CAN ECU SHUTDOWN	The engine ECU has detected an alarm – CHECK ENGINE LIGHT Contact Engine Manufacturer for support.
	CAN DATA FAIL	The module is configured for CAN operation and does not detect data on the engine Can datalink.
	EMERGENCY STOP	The emergency stop button has been depressed. This a failsafe (normally closed to battery positive) input and will immediately stop the set should the signal be removed. Removal of the battery positive supply from the emergency stop input will also remove DC supply from the Fuel and Start outputs of the controller. ▲NOTE:- The Emergency Stop Positive signal must be present otherwise the unit will shutdown.
	MAGNETIC PICKUP FAILURE	Pulses are no longer being detected from the magnetic pickup probe (3110-xxx-01 magnetic pickup version only)
	INTERNAL MEMORY ERROR	Either the configuration file or engine file memory is corrupted. Contact your supplier for assistance.



9 FRONT PANEL CONFIGURATION

This configuration mode allows the operator limited customising of the way the module operates.

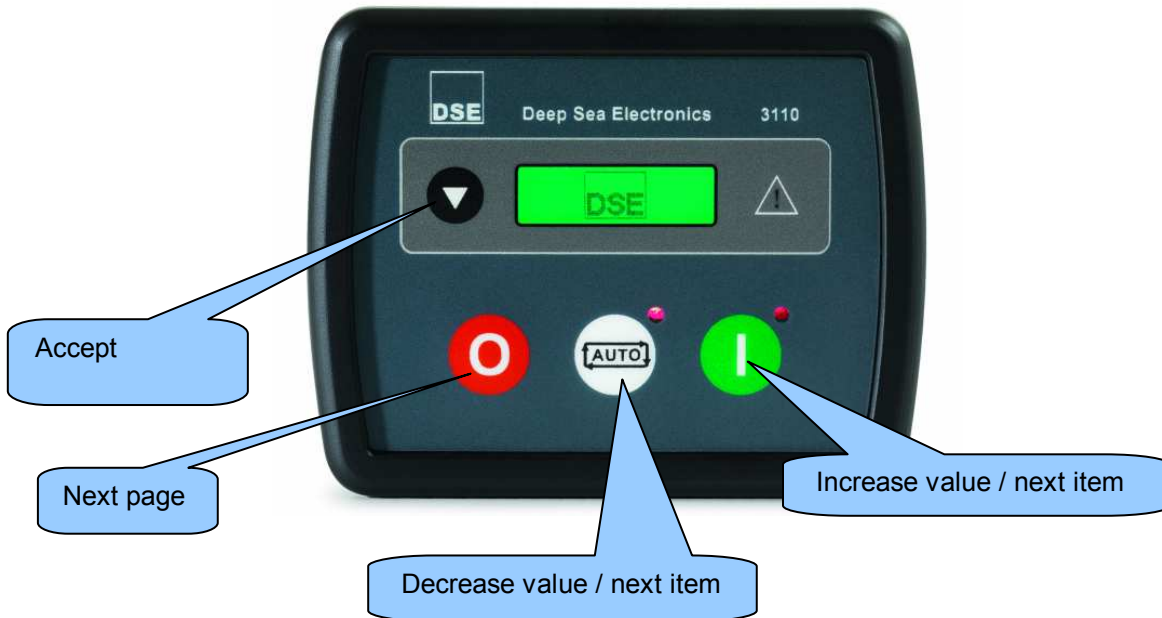
Use the module's navigation buttons to traverse the menu and make value changes to the parameters:



9.1 ACCESSING THE FRONT PANEL EDITOR (FPE)

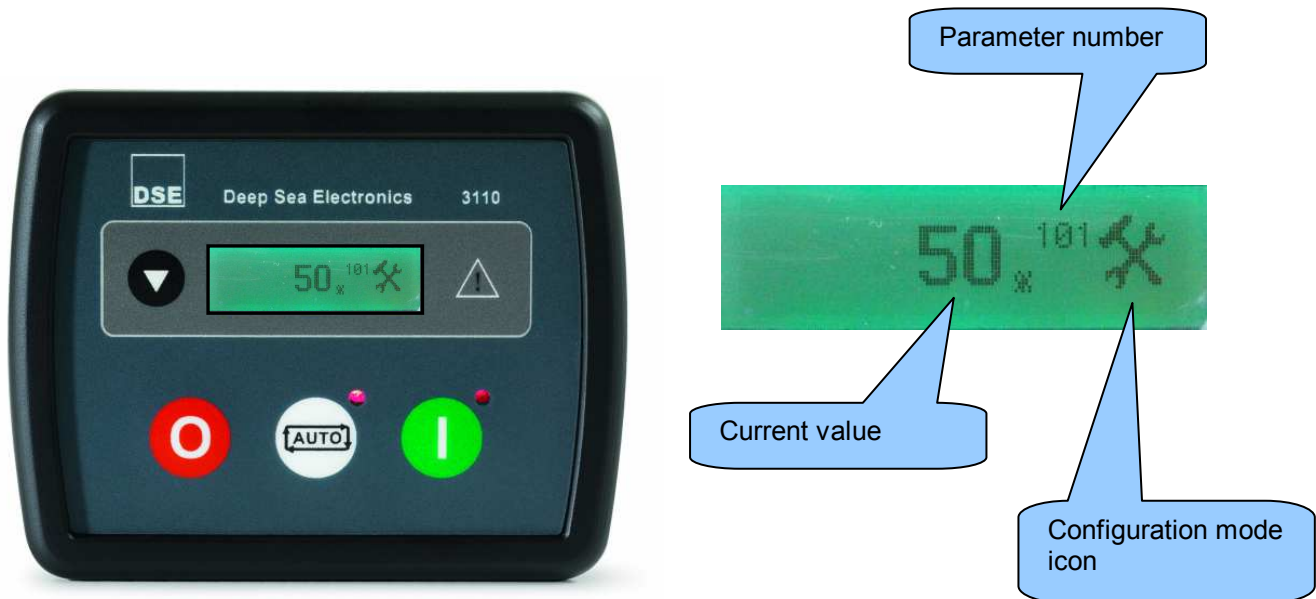

Press  and  buttons simultaneously. The display shows the configuration icon : 
The first parameter is also displayed.





9.1.1 EDITING A PARAMETER

Enter the editor as described above.



Press  to select the required 'page' as detailed below).

Press  (+) to select the next parameter or  (-) to select the previous parameter within the current page.

When viewing the parameter to be changed, press the  button. The value begins to flash.

Press  (+) or  (-) to adjust the value to the required setting.

Press  to save the current value, the value ceases flashing.

Press and hold the  button to exit the editor, the configuration icon  is removed from the display.

▲NOTE: - Values representing pressure will be displayed in Bar. Values representing temperature are displayed in degrees Celsius.

▲NOTE: - When adjusting values in the FPE a press and hold of the increment button will cover the full range of the item being adjusted (min to max) in under 20 seconds.

▲NOTE: - When the editor is visible, it is exited after 5 minutes of inactivity to ensure security.

9.1.2 ADJUSTABLE PARAMETERS

CONFIGURATION PARAMETERS – MODULE (Page 1)			
101	Contrast	000 (%)	
102	RESERVED		
103	RESERVED		
104	Lamp test at startup	On (1), Off (0)	
105	Power save mode enable	On (1), Off (0)	
106	Protected start enable	On (1), Off (0)	
107	Start in Auto	On (1), Off (0)	
108	Oil pressure display	PSI (1), Bar (0)	CAN
109	Display Volts in Ph-Ph	On (1), Off (0)	
110	Temperature display	°F(1), °C(0)	CAN





CONFIGURATION PARAMETERS – APPLICATION (Page 2)			
201	Default configuration	On (1), Off (0)	CAN
202	Alternate Engine Speed	On (1), Off (0)	CAN
203	CAN ECU data fail enable	On (1), Off (0)	CAN
204	CAN ECU data fail action	0 (Action)	CAN
205	CAN ECU data fail delay	0:00	CAN

CONFIGURATION PARAMETERS – INPUTS (Page 3)			
301	Low oil pressure enable	On (1), Off (0)	CAN
302	Low oil pressure trip	0.00 bar	CAN
303	High engine temperature trip	00 deg C	CAN
304	Digital input 1 source	0 (Input source)	
305	Digital input 1 polarity	0 (Polarity)	
306	Digital input 1 action (if source = user config)	0 (Action)	
307	Digital input 1 arming (if source = user config)	0 (Arming)	
308	RESERVED		
309	Digital input 2 source	0 (Input source)	
310	Digital input 2 polarity	0 (Polarity)	
311	Digital input 2 action (if source = user config)	0 (Action)	
312	Digital input 2 arming (if source = user config)	0 (Arming)	
313	RESERVED		
314	Digital input 3 source	0 (Input source)	
315	Digital input 3 polarity	0 (Polarity)	
316	Digital input 3 action (if source = user config)	0 (Action)	
317	Digital input 3 arming (if source = user config)	0 (Arming)	
318	RESERVED		
319	Digital input 4 source	0 (Input source)	
320	Digital input 4 polarity	0 (Polarity)	
321	Digital input 4 action (if source = user config)	0 (Action)	
322	Digital input 4 arming (if source = user config)	0 (Arming)	
323	RESERVED		
324	Digital input 5 source	0 (Input source)	
325	Digital input 5 polarity	0 (Polarity)	
326	Digital input 5 action (if source = user config)	0 (Action)	
327	Digital input 5 arming (if source = user config)	0 (Arming)	
328	RESERVED		
329	Digital input 6 source	0 (Input source)	
330	Digital input 6 polarity	0 (Polarity)	
331	Digital input 6 action (if source = user config)	0 (Action)	
332	Digital input 6 arming (if source = user config)	0 (Arming)	
333	RESERVED		

CONFIGURATION PARAMETERS – OUTPUTS (Page 4)	
401	Digital output 1 source
402	Digital output 1 polarity
403	Digital output 2 source
404	Digital output 2 polarity
405	Digital output 3 source
406	Digital output 3 polarity
407	Digital output 4 source
408	Digital output 4 polarity

CONFIGURATION PARAMETERS – TIMERS (Page 5)		
501	Remote Start Delay	0:00
502	Preheat timer	0:00
503	RESERVED	
504	RESERVED	
505	Smoke limiting	0:00
506	Smoke limiting off	0:00
507	RESERVED	
508	Warm up time	0:00
509	Return Delay	0:00
510	Cooling Time	0:00
511	ETS Solenoid Hold	0:00
512	RESERVED	
513	RESERVED	
514	RESERVED	
515	Breaker trip pulse	0:00
516	Breaker close pulse	0:00

CONFIGURATION PARAMETERS – GENERATOR (Page 6)		
601	Alternator Fitted	On (1), Off (0)
602	Alternator Poles	0
603	RESERVED	
604	RESERVED	
605	Under Voltage trip enabled	On (1), Off (0)
606	Under Voltage trip level	0 V
607	Loading Voltage	0 V
608	Over Voltage trip level	0 V
609	Under frequency trip enable	On (1), Off (0)
610	Under frequency trip level	0.0 Hz
611	Loading Frequency	0.0 Hz
612	Nominal Frequency	0.0 Hz
613	Over frequency trip enable	On (1), Off (0)
614	Over Frequency trip level	0.0 Hz
615	AC System	Selection List

CONFIGURATION PARAMETERS – ENGINE (Page 7)			
701	Magnetic pickup fitted	On (1), Off (0)	
702	Flywheel teeth	000	
703	Start Attempts	0	
704	RESERVED		
705	RESERVED		
706	Gas choke timer (Gas engine only)	0:00	
707	Gas on delay (Gas engine only)	0:00	
708	Gas ignition off delay (Gas engine only)	0:00	
709	Crank disconnect on Oil enable	On (1), Off (0)	
710	Check oil pressure prior to starting	On (1), Off (0)	
711	Crank disconnect on Oil threshold	0.00 Bar	
712	Crank disconnect on frequency	0.0Hz	
713	Crank disconnect on Engine Speed	000 rpm	
714	Under speed enable	On (1), Off (0)	
715	Under speed trip	0000 rpm	
716	Over speed trip	0000 rpm	
717	RESERVED		
718	RESERVED		
719	RESERVED		
720	RESERVED		
721	RESERVED		
722	RESERVED		
723	RESERVED		
724	RESERVED		
725	Charge alt failure enable	On (1), Off (0)	
726	Charge alt failure trip	00.0 V	

CONFIGURATION PARAMETERS – ALTERNATIVE CONFIGURATION (Page 8)		
801	Alt config – Enable configuration	On (1), Off (0)
802	Alt config - Alternative Engine Speed	On (1), Off (0)
803	Alt config – Ender Voltage Shutdown Enable	On (1), Off (0)
804	Alt config - Under Voltage trip	On (1), Off (0)
805	Alt config - Under Voltage trip level	0 V
806	Alt config - Loading Voltage	0 V
807	Alt config - Over Voltage trip level	0 V
808	Alt config - Under frequency enabled	On (1), Off (0)
809	Alt config - Under frequency trip level	0.0 Hz
810	Alt config - Loading Frequency	0.0 Hz
811	Alt config - Nominal Frequency	0.0 Hz
812	Alt config - Over Frequency enabled	On (1), Off (0)
813	Alt config - Over Frequency trip level	0.0 Hz
814	Alt config - Alternative Under speed enable	On (1), Off (0)
815	Alt config - Alternative Under speed trip	0000 rpm
816	Alt config - Alternative Over speed trip	0000 rpm

Parameters with multiple choices use the following identification tables for the parameter values.

INPUT SOURCE LIST	
0	User Configured
1	RESERVED
2	RESERVED
3	Alternative configuration
4	Coolant Temperature Switch
5	Emergency Stop
6	External Panel Lock
7	RESERVED
8	RESERVED
9	Low Fuel Level Switch
10	Oil Pressure Switch
11	Remote Start Off Load
12	Remote Start On Load
13	Smoke Limiting

INPUT ACTION LIST	
Index	Action
0	Electrical Trip
1	Shutdown
2	Warning

INPUT POLARITY LIST	
Index	Action
0	Close to Activate
1	Open to Activate

CAN DATA FAIL ACTION	
Index	Action
0	None
1	Shutdown
2	Warning always latched

INPUT ARMING LIST	
Index	Arming
0	Always
1	From Safety On
2	From Starting
3	Never







OUTPUT POLARITY LIST	
Index	Arming
0	Energise
1	De-energise

CAN DATA FAIL ARMING	
Index	Arming
0	From Safety On
1	From Starting

AC SYSTEM		
Index	AC System	Instrumentation
0	Single phase 2 wire	L-N
1	2 phase, 3 wire (L12/L13)	L-N x 2
2	3 phase, 4 wire	L-N x sqrt(3)
3	3 phase, 3 wire delta	L-N
4	3 phase, 4 wire delta	L-N x 2

 = 3110 – xxx – 02 (CAN) option only

 = 3110 – xxx – 01 (Magnetic pickup) option only

OUTPUT SOURCE LIST		
0	Not used	
1	RESERVED	
2	RESERVED	
3	RESERVED	
4	RESERVED	
5	RESERVED	
6	CAN ECU data fail	
7	CAN ECU error	
8	CAN ECU fail	
9	CAN ECU power	
10	CAN ECU stop	
11	RESERVED	
12	Close Gen output	
13	Close Gen output pulse	
14	Common Alarm	
15	Common Shutdown	
16	Common Warning	
17	RESERVED	
18	RESERVED	
19	RESERVED	
20	RESERVED	
21	RESERVED	
22	RESERVED	
23	RESERVED	
24	RESERVED	
25	Energise to stop	
26	RESERVED	
27	RESERVED	
28	Fuel relay	
29	Gas choke on	
30	Gas ignition	
31	RESERVED	
32	RESERVED	
33	RESERVED	
34	RESERVED	
35	RESERVED	
36	RESERVED	
37	RESERVED	
38	Open Gen Output	
39	Open Gen Output pulse	
40	RESERVED Plant battery over volts warning	
41	RESERVED Plant battery under volts warning	
42	Preheat During Preheat Timer	
43	Preheat Until End of Crank	
44	Preheat Until End of Safety Timer	
45	Preheat Until End of Warming Timer	
46	Smoke limiting	
47	Start relay	
48	RESERVED Under frequency shutdown	
49	RESERVED Under speed shutdown	

 = 3110 – xxx – 02 (CAN) option only

 = 3110 – xxx – 01 (Magnetic pickup) option only

10 COMMISSIONING

10.1.1 PRE-COMMISSIONING

Before the system is started, it is recommended that the following checks are made:-

- 10.1. The unit is adequately cooled and all the wiring to the module is of a standard and rating compatible with the system. Check all mechanical parts are fitted correctly and that all electrical connections (including earths) are sound.
- 10.2. The unit **DC** supply is fused and connected to the battery and that it is of the correct polarity.
- 10.3. The Emergency Stop input is wired to a user-configured input on the module and to an external normally closed switch connected to **DC** negative.

 **NOTE:- If Emergency Stop feature is not required, ensure there is not input configured for the function.**

- 10.4. To check the start cycle operation, take appropriate measures to prevent the engine from starting (disable the operation of the fuel solenoid). After a visual inspection to ensure it is safe to proceed, connect the battery supply. Select "**MANUAL**" and then press "**START**" the unit start sequence will commence.
- 10.5. The starter will engage and operate for the pre-set crank period. After the starter motor has attempted to start the engine for the pre-set number of attempts, the LCD will display 'Failed to start'. Select the **STOP/RESET** position to reset the unit.
- 10.6. Restore the engine to operational status (reconnect the fuel solenoid). Select "**MANUAL**" and then press "**START**". This time the engine should start and the starter motor should disengage automatically. If not then check that the engine is fully operational (fuel available, etc.) and that the fuel solenoid is operating. The engine should now run up to operating speed. If not, and an alarm is present, check the alarm condition for validity, then check input wiring. The engine should continue to run for an indefinite period. It will be possible at this time to view the engine and alternator parameters - refer to the 'Description of Controls' section of this manual.
- 10.7. Select "**AUTO**" on the front panel, the engine will run for the pre-set cooling down period, then stop. The generator should stay in the standby mode. If not check that there is not a signal present on the **Remote start** input.
- 10.8. Initiate an automatic start by supplying the remote start signal (if configured). The start sequence will commence and the engine will run up to operational speed. Once the generator is available a load transfer will take place (if configured), the Generator will accept the load. If not, check the wiring to the Generator Contactor Coil (*if used*). Check the Warming timer has timed out.
- 10.9. Remove the remote start signal. The return sequence will begin. After the pre-set time, the generator is unloaded. The generator will then run for the pre-set cooling down period, then shutdown into its standby mode.
- 10.10. If, despite repeated checking of the connections between the **3000** series controller and the customer's system, satisfactory operation cannot be achieved, then the customer is requested to contact the factory for further advice on:-

INTERNATIONAL TEL: +44 (0) 1723 890099

INTERNATIONAL FAX: +44 (0) 1723 893303

E-mail: Support@Deepseapl.com

Website : www.deepseapl.com

11 FAULT FINDING

SYMPTOM	POSSIBLE REMEDY
Unit is inoperative Read/Write configuration does not operate	Check the battery and wiring to the unit. Check the DC supply. Check the DC fuse.
Unit shuts down	Check DC supply voltage is not above 35 Volts or below 9 Volts Check the operating temperature is not above 70°C. Check the DC fuse.
Unit locks out on Emergency Stop	If no Emergency Stop Switch is fitted, ensure that a DC positive signal is connected to the Emergency Stop input. Check emergency stop switch is functioning correctly. Check Wiring is not open circuit.
Intermittent Magnetic Pick-up sensor fault	Ensure that Magnetic pick-up screen only connects to earth at one end, if connected at both ends, this enables the screen to act as an aerial and will pick up random voltages. Check pickup is correct distance from the flywheel teeth.
Low oil Pressure fault operates after engine has fired	Check engine oil pressure. Check oil pressure switch/sensor and wiring. Check configured polarity (if applicable) is correct (i.e. Normally Open or Normally Closed) or that sensor is compatible with the 3310 Module and is correctly configured.
High engine temperature fault operates after engine has fired.	Check engine temperature. Check switch/sensor and wiring. Check configured polarity (if applicable) is correct (i.e. Normally Open or Normally Closed) or that sensor is compatible with the 3000 series module.
Shutdown fault operates	Check relevant switch and wiring of fault indicated on LCD display. Check configuration of input.
Warning fault operates	Check relevant switch and wiring of fault indicated on LCD display. Check configuration of input.
Fail to Start is activated after pre-set number of attempts to start	Check wiring of fuel solenoid. Check fuel. Check battery supply. Check battery supply is present on the Fuel output of the module. Check the speed-sensing signal is present on the 3000 series module inputs. Refer to engine manual.
Continuous starting of generator when in AUTO	Check that there is no signal present on the "Remote Start" input. Check configured polarity is correct.
Generator fails to start on receipt of Remote Start signal.	Check Start Delay timer has timed out. Check signal is on "Remote Start" input. Confirm correct configuration of input is configured to be used as "Remote Start". Check that the oil pressure switch or sensor is indicating low oil pressure to the controller. Depending upon configuration, the set will not start if oil pressure is not low.
Pre-heat inoperative	Check wiring to engine heater plugs. Check battery supply. Check battery supply is present on the Pre-heat output of module. Check pre-heat configuration is correct.
Starter motor inoperative	Check wiring to starter solenoid. Check battery supply. Check battery supply is present on the Starter output of module. Ensure that the Emergency Stop input is at Positive. Ensure oil pressure switch or sensor is indicating the "low oil pressure" state to the 3000 series controller.
Engine runs but generator will not take load	Check Warm up timer has timed out. Ensure generator load inhibit signal is not present on the module inputs. Check connections to the switching device. Note that the set will not take load in manual mode unless there is an active remote start on load signal.

SYMPTOM	POSSIBLE REMEDY
<p>Incorrect reading on Engine gauges</p> <p>Fail to stop alarm when engine is at rest</p>	<p>Check engine is operating correctly. Check sensor and wiring.</p>
<p>Module appears to 'revert' to an earlier configuration</p>	<p>When editing a configuration using the PC software it is vital that the configuration is first 'read' from the controller before editing it. This edited configuration must then be "written" back to the controller for the changes to take effect.</p> <p>When editing a configuration using the Front Panel Editor, be sure to press the Save  button to save the change before moving to another item or exiting the Front Panel Editor.</p>
<p>Set will not take load</p>	<p>Ensure the generator is available.</p> <p>Check that the output configuration is correct to drive the load switch device and that all connections are correct.</p> <p>Remember that the set will not take load in manual mode unless a remote start on load input is present.</p>
<p>Inaccurate generator measurements on controller display</p>	<p>The 3000 series controller is true RMS measuring so gives more accurate display when compared with an 'average' meter such as an analogue panel meter or some lower specified digital multimeters.</p> <p>Accuracy of the controller is better than 1% of full scale. Ie Gen volts full scale is 333V ph-n so accuracy is $\pm 3.33V$ (1% of 333V).</p>

 **NOTE:-** The above fault finding is provided as a guide check-list only. As the module can be configured to provide a wide range of different features, always refer to the source of your module configuration if in doubt.



12 MAINTENANCE, SPARES, REPAIR AND SERVICING

The DSE3000 Series controller is designed to be *Fit and Forget*. As such, there are no user serviceable parts within the controller.

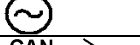

In the case of malfunction, you should contact your original equipment supplier (OEM).

12.1 PURCHASING ADDITIONAL CONNECTOR PLUGS FROM DSE

If you require additional plugs from DSE, please contact our Sales department using the part numbers below.

7000 series terminal designation	Plug description	Part No.
1-7 	7 way 5.08mm	007-447
8-9 	2 way 7.62mm	007-448
10-17 	8 way 5.08mm	007-164

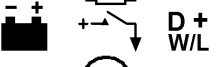
Alternatively, you can purchase a pack containing all three connectors under one part number:

7000 series terminal designation	Plug description	Part No.
1-7 	7 way 5.08mm	007-515
8-9 	2 way 7.62mm	
10-17 	8 way 5.08mm	

12.2 PURCHASING ADDITIONAL FIXING CLIPS FROM DSE

Item	Description	Part No.
	3000 series fixing clips (packet of 4)	020-294

12.3 PURCHASING SEALING GASKET FROM DSE

The optional sealing gasket is not supplied with the controller but can be purchased separately.

Item	Description	Part No.
	3000 series silicon sealing gasket	020-385

13 WARRANTY

DSE provides limited warranty to the equipment purchaser at the point of sale. For full details of any applicable warranty, you are referred to your original equipment supplier (OEM).

14 DISPOSAL

14.1 WEEE (WASTE ELECTRICAL AND ELECTRONIC EQUIPMENT)

If you use electrical and electronic equipment you must store, collect, treat, recycle and dispose WEEE separately from your other waste.



15 APPENDIX

15.1 CAN INTERFACE

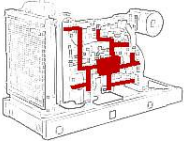

3110-000-02 Modules are fitted with the CAN interface and are capable of receiving engine data from engine CAN controllers compliant with the CAN standard.

CAN enabled engine controllers monitor the engines operating parameters such as engine speed, oil pressure, engine temperature (among others) in order to closely monitor and control the engine. The industry standard communications interface

(CAN) transports data gathered by the engine controller interface (CAN). This allows generator controllers such as the DSE 3110 to access these engine parameters with no physical connection to the sensor device.

▲ NOTE:- For further details for connections to CAN enabled engines and the functions available with each engine type, refer to the manual *Electronic Engines and DSE Wiring*, Part No. 057-004

15.2 COMMUNICATIONS OPTION CONNECTIONS

15.2.1 DESCRIPTION

The 3000 series configuration software allows the controller to communicate with a PC. The computer connects to the module as shown below and allows easy adjustment of the operating parameters and firmware update of the controller.

15.2.2 PC TO CONTROLLER (DIRECT) CONNECTION

To connect a 3000 series module to a PC the following items are required: -

- 3000 series module
- 3000 series configuration software (Supplied on configuration suite software CD).
- USB cable Type A to Type B.



NOTE:- The DC supply must be connected to the module for configuration by PC.

NOTE:- Refer to 3xxx software Manual for further details on configuring the module by PC.

15.3 ENCLOSURE CLASSIFICATIONS

IP CLASSIFICATIONS

3000 series specification under BS EN 60529 Degrees of protection provided by enclosures

IP65 (Front of module when module is installed into the control panel with the supplied sealing gasket).

IP42 (front of module when module is installed into the control panel WITHOUT being sealed to the panel)

First Digit	Second Digit
Protection against contact and ingress of solid objects 0 No protection	Protection against ingress of water 0 No protection
1 Protected against ingress solid objects with a diameter of more than 50 mm. No protection against deliberate access, e.g. with a hand, but large surfaces of the body are prevented from approach.	1 Protection against dripping water falling vertically. No harmful effect must be produced (vertically falling drops).
2 Protected against penetration by solid objects with a diameter of more than 12 mm. Fingers or similar objects prevented from approach.	2 Protection against dripping water falling vertically. There must be no harmful effect when the equipment (enclosure) is tilted at an angle up to 15° from its normal position (drops falling at an angle).
3 Protected against ingress of solid objects with a diameter of more than 2.5 mm. Tools, wires etc. with a thickness of more than 2.5 mm are prevented from approach.	3 Protection against water falling at any angle up to 60° from the vertical. There must be no harmful effect (spray water).
4 Protected against ingress of solid objects with a diameter of more than 1 mm. Tools, wires etc. with a thickness of more than 1 mm are prevented from approach.	4 Protection against water splashed against the equipment (enclosure) from any direction. There must be no harmful effect (splashing water).
5 Protected against harmful dust deposits. Ingress of dust is not totally prevented but the dust must not enter in sufficient quantity to interface with satisfactory operation of the equipment. Complete protection against contact.	5 Protection against water projected from a nozzle against the equipment (enclosure) from any direction. There must be no harmful effect (water jet).
6 Protection against ingress of dust (dust tight). Complete protection against contact.	6 Protection against heavy seas or powerful water jets. Water must not enter the equipment (enclosure) in harmful quantities (splashing over).

NEMA CLASSIFICATIONS

3000 series NEMA Rating (Approximate)

12 (Front of module when module is installed into the control panel with the optional sealing gasket).

2 (front of module when module is installed into the control panel WITHOUT being sealed to the panel)

 **NOTE: - There is no direct equivalence between IP / NEMA ratings. IP figures shown are approximate only.**

1 IP30	Provides a degree of protection against contact with the enclosure equipment and against a limited amount of falling dirt.
2 IP31	Provides a degree of protection against limited amounts of falling water and dirt.
3 IP64	Provides a degree of protection against windblown dust, rain and sleet; undamaged by the formation of ice on the enclosure.
3R IP32	Provides a degree of protection against rain and sleet;; undamaged by the formation of ice on the enclosure.
4 (X) IP66	Provides a degree of protection against splashing water, windblown dust and rain, hose directed water; undamaged by the formation of ice on the enclosure. (Resist corrosion).
12/12K IP65	Provides a degree of protection against dust, falling dirt and dripping non corrosive liquids.
13 IP65	Provides a degree of protection against dust and spraying of water, oil and non corrosive coolants.